



DEEBOT™ **18** AIVI+  
Instruction Manual/說明書

<b>EN</b>	Instruction Manual.....	2
<b>ZH-TW</b>	說明書.....	41

---

Live Smart. Enjoy Life.

Should you encounter situations that have not been properly addressed in this Instruction Manual, please contact our Customer Service Center where a technician will be able to help you with your specific problem or question.

For more information, please visit the ECOVACS ROBOTICS official website: [www.ecovacs.com](http://www.ecovacs.com)

The company reserves the right to make technological and/or design changes to this product for continuous improvement.

**Thank you for choosing DEEBOT!**

# Contents

1. Important Safety Instructions .....	4
2. Package Contents .....	8
3. Operating and Programming.....	13
4. Maintenance .....	21
5. Status Indicator .....	31
6. Troubleshooting.....	32
7. Product Specifications.....	39

# 1. Important Safety Instructions

## IMPORTANT SAFETY INSTRUCTIONS

When using an electrical Appliance, basic precautions should always be followed, including the following:

### **READ ALL INSTRUCTIONS BEFORE USING THIS APPLIANCE SAVE THESE INSTRUCTIONS**

1. This Appliance is not intended for use by persons (including children) with reduced physical, sensory or mental capabilities, or lack of experience and knowledge, unless they have been given supervision or instruction concerning use of the Appliance by a person responsible for their safety.
2. Children should be supervised to ensure that they do not play with the Appliance.
3. Clear the area to be cleaned. Remove power cords and small objects from the floor that could entangle the Appliance. Tuck rug fringe under the rug base, and lift items such as curtains and tablecloths off the floor.
4. If there is a drop off in the cleaning area due to a step or stairs, you should operate the

Appliance to ensure that it can detect the step without falling over the edge. It may become necessary to place a physical barrier at the edge to keep the unit from falling. Make sure the physical barrier is not a trip hazard.

5. Only use as described in this manual. Only use attachments recommended or sold by the manufacturer.
6. Please make sure your power supply source voltage matches the power voltage marked on the Docking Station.
7. For INDOOR household use ONLY. Do not use the Appliance in outdoor, commercial or industrial environments.
8. Use only the original rechargeable battery and Docking Station provided with the Appliance from the manufacturer. Non-rechargeable batteries are prohibited. For battery information, please refer to Specifications section.
9. Do not use without dust bin and/or filters in place.
10. Do not operate the Appliance in an area where there are lit candles or fragile objects.
11. Do not use in extremely hot or cold environments (below -5°C/23°F or above 40°C/104°F).
12. Keep hair, loose clothing, fingers, and all

parts of body away from any openings and moving parts.

13. Do not operate the Appliance in a room where an infant or child is sleeping.
14. Do not use Appliance on wet surfaces or surfaces with standing water.
15. Do not allow the Appliance to pick up large objects like stones, large pieces of paper or any item that may clog the Appliance.
16. Do not use Appliance to pick up flammable or combustible materials such as gasoline, printer or copier toner, or use in areas where they may be present.
17. Do not use Appliance to pick up anything that is burning or smoking, such as cigarettes, matches, hot ashes, or anything that could cause a fire.
18. Do not put objects into the suction intake. Do not use if the suction intake is blocked. Keep the intake clear of dust, lint, hair, or anything that may reduce air flow.
19. Take care not to damage the power cord. Do not pull on or carry the Appliance or Docking Station by the power cord, use the power cord as a handle, close a door on the power cord, or pull power cord around sharp edges

or corners. Do not run Appliance over the power cord. Keep power cord away from hot surfaces.

20. If the power cord is damaged, it must be replaced by the manufacturer or its service agent in order to avoid a hazard.
21. Do not use the Docking Station if it is damaged. The power supply is not to be repaired and not to be used any longer if it is damaged or defective.
22. Do not use with a damaged power cord or receptacle. Do not use the Appliance or Docking Station if it is not working properly, has been dropped, damaged, left outdoors, or come in contact with water. It must be repaired by the manufacturer or its service agent in order to avoid a hazard.
23. Turn OFF the power switch before cleaning or maintaining the Appliance.
24. The plug must be removed from the receptacle before cleaning or maintaining the Docking Station.
25. Remove the Appliance from the Docking Station, and turn OFF the power switch to the Appliance before removing the battery for disposal of the Appliance.

26. The battery must be removed and discarded according to local laws and regulations before disposal of the Appliance.
27. Please dispose of used batteries according to local laws and regulations.
28. Do not incinerate the Appliance even if it is severely damaged. The batteries can explode in a fire.
29. When not using the Docking Station for a long period of time, please unplug it.
30. The Appliance must be used in accordance with the directions in this Instruction Manual. ECOVACS ROBOTICS cannot be held liable or responsible for any damages or injuries caused by improper use.
31. The robot contains batteries that are only replaceable by skilled persons. To replace the robot's battery, please contact Customer Service.
32. If the robot will not be used for a long time, power OFF the robot for storage and unplug the Docking Station.
33. **WARNING:** For the purposes of recharging the battery, only use the detachable supply unit CH1918 provided with the Appliance or CH1822 sold separately as an accessory. (For Hong Kong only)
34. **WARNING:** For the purposes of recharging the battery, only use the detachable supply unit CH1918 provided with the Appliance. (For Taiwan only)
35. This Appliance can be used by children aged from 8 years and above and persons with reduced physical, sensory or mental capabilities or lack of experience and knowledge if they have been given supervision or instruction concerning use of the Appliance in a safe way and understand the hazards involved. Children shall not play with the Appliance. Cleaning and user maintenance shall not be made by children without supervision. (For EU Countries)

To disable Wi-Fi module on DEEBOT, power the robot ON.







Place the robot on the Docking Station making sure the Charging Contacts on DEEBOT and the Docking Station Pins make a connection.

Press and hold the AUTO Mode Button on the robot for 20 seconds until DEEBOT emits 3 beeps.

To enable Wi-Fi module on DEEBOT, power the robot OFF and then power ON. The Wi-Fi module is turned on when DEEBOT is restarted.

To satisfy RF exposure requirements, a separation distance of 20 cm or more should be maintained between this device and persons during device operation.

To ensure compliance, operations at closer than this distance is not recommended. The antenna used for this transmitter must not be co-located in conjunction with any other antenna or transmitter.

	Class II
	Short-circuit-proof safety isolating transformer
	Switch mode power supply
	For indoor use only
	Direct current
	Alternating current

## For EU Countries

For EU Declaration of Conformity information, visit <https://www.ecovacs.com/global/compliance>



### Correct Disposal of this Product

This marking indicates that this product should not be disposed of with other household waste throughout the EU. To prevent possible harm to the environment or human health from uncontrolled waste disposal, recycle it responsibly to promote the sustainable reuse of material resources. To recycle your used device, please use the return and collection systems or contact the retailer where the product was purchased. They can safely recycle this product.

## 2. Package Contents/2.1 Package Contents

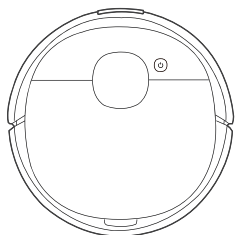

Robot

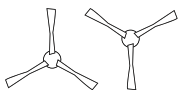

Side Brushes

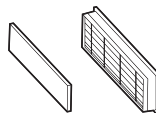

High Efficiency Filter and  
Sponge Filter

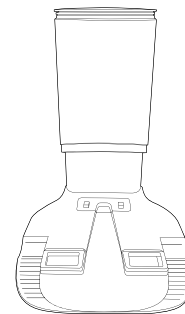

Auto-Empty Station

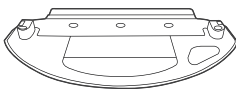

Cleaning Cloth Plate

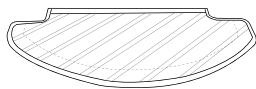

Washable/Reusable  
Microfiber Cleaning Cloth



OZMO Pro  
Oscillating System

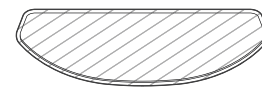

Disposable Cleaning  
Cloths



Instruction Manual

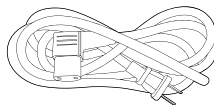

Power Cord

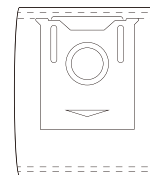

Dust Bag

**Note:** Figures and illustrations are for reference only and may differ from actual product appearance. Product design and specifications are subject to changes without notice.



## 2. Package Contents/2.2 Product Diagram

### Robot

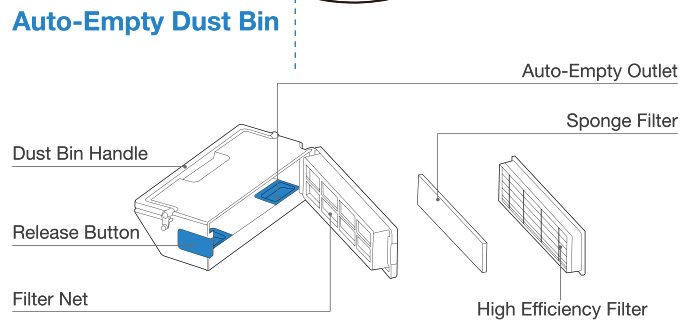
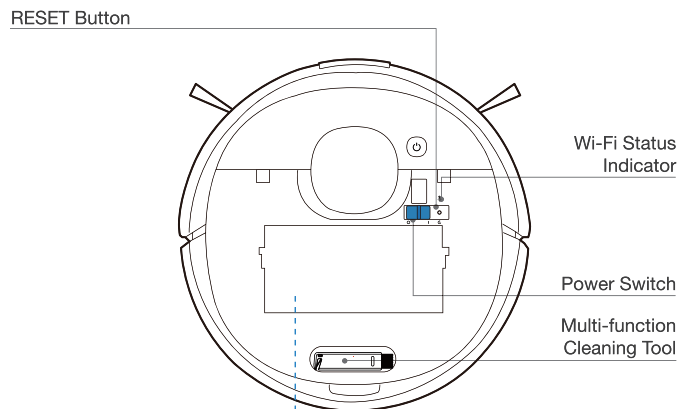
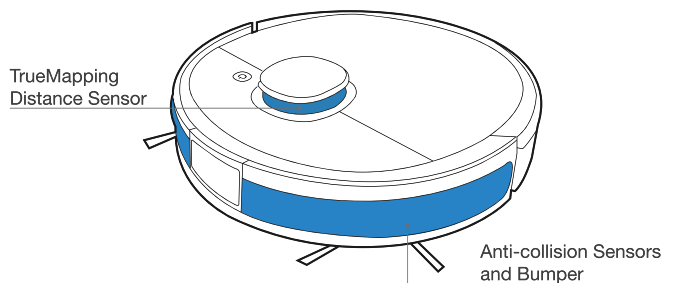
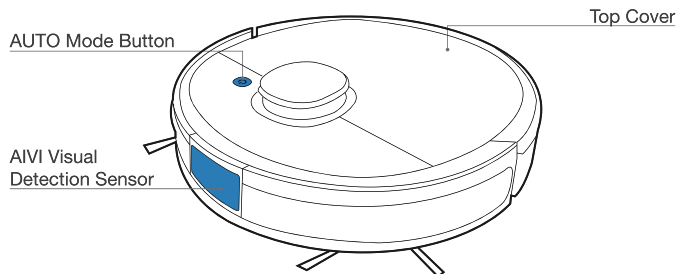

## Bottom View

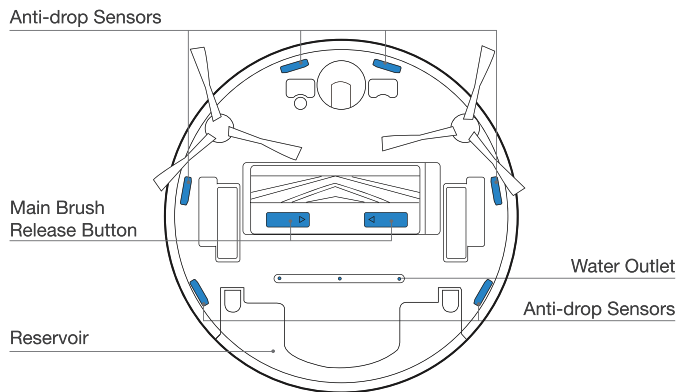
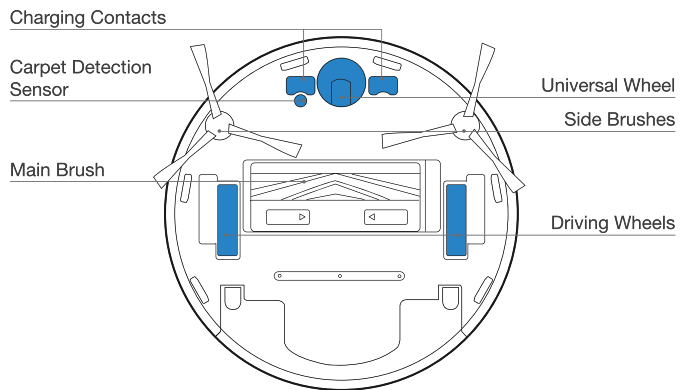

## Auto-Empty Station

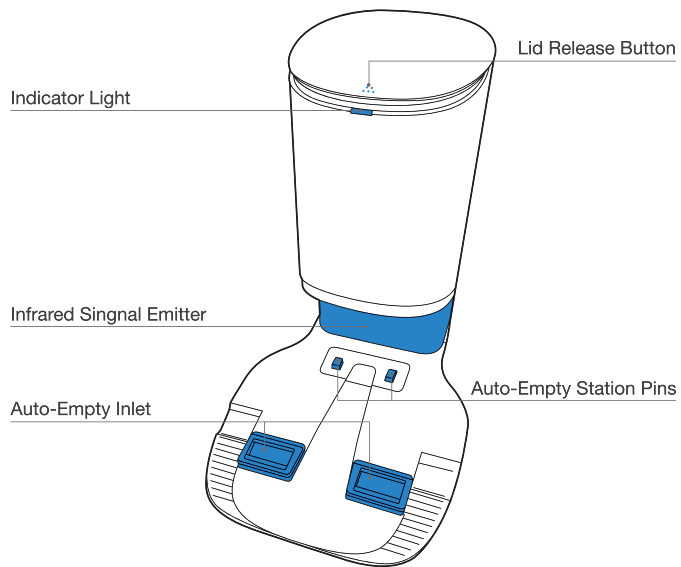

## Auto-Empty Station (Back)

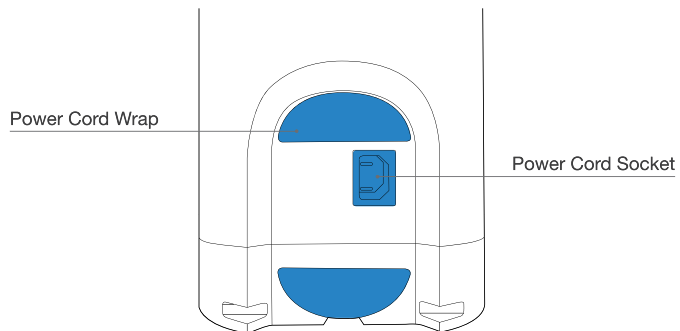

## Auto-Empty Station (Top)

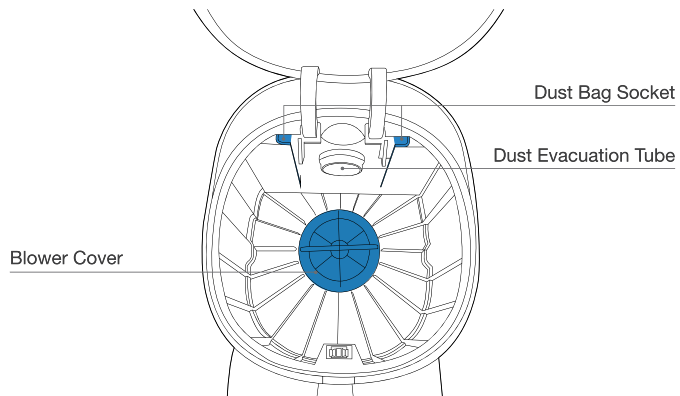

## Auto-Empty Station (Bottom)

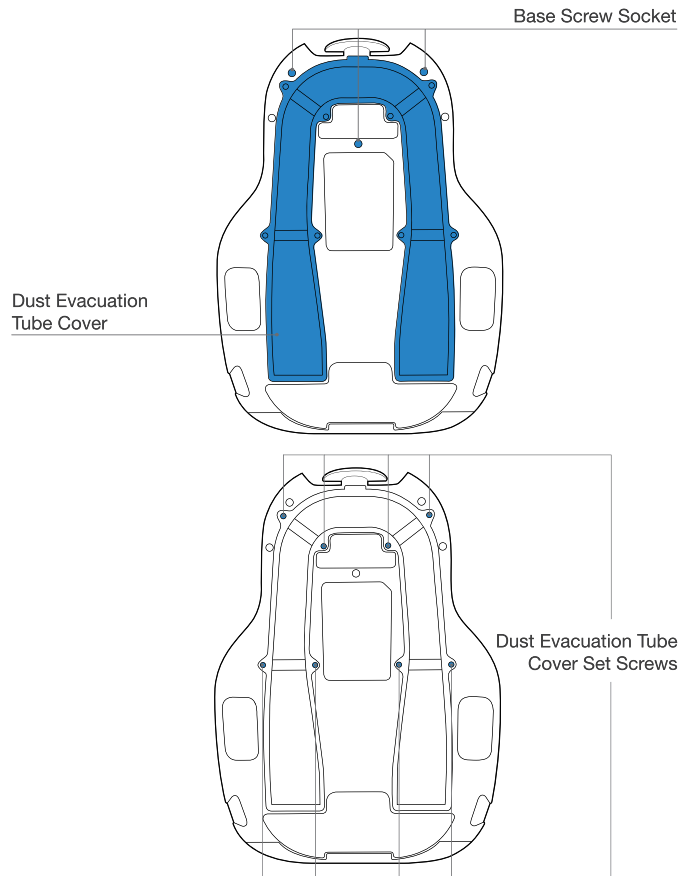

## Dust Bag

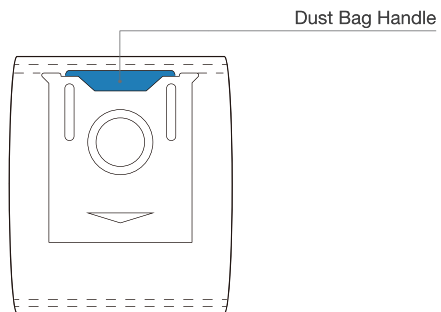

## OZMO Pro Oscillating System

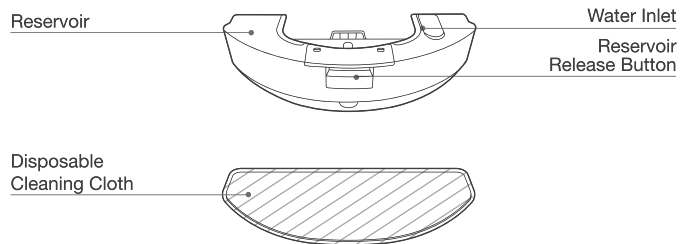

## Power Cord

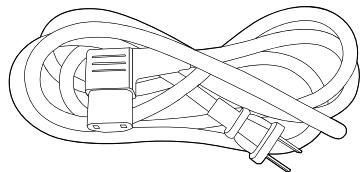

## OZMO Mopping System

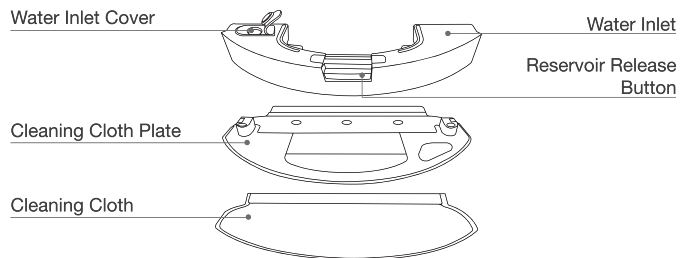

### 3. Operating and Programming/3.1 Notes Before Cleaning

Tidy up the area to be cleaned by putting furniture, such as chairs, in their proper place.

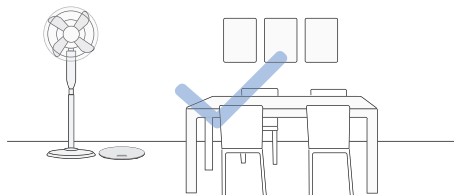

During the first use, make sure each room door is open to help DEEBOT fully explore your house.

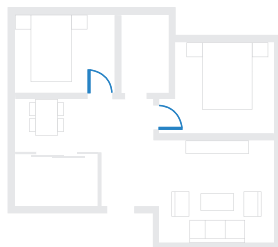

It may be necessary to place a physical barrier at the edge of a drop to stop the unit from falling over the edge.

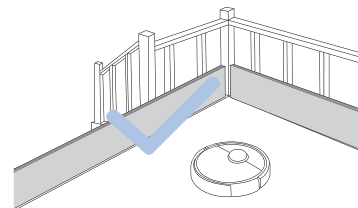

Make sure areas to be cleaned are well illuminated so Visual Detection works properly. Remove power cords and small objects from the floor to ensure cleaning efficiency.

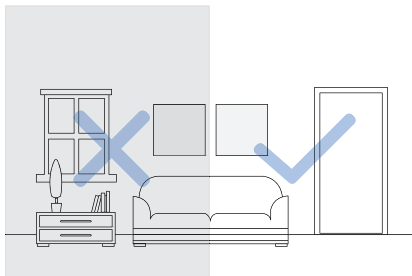

Put away objects including wires, cloths and slippers, etc. on the floor to improve the cleaning efficiency.



Clean the AIVI Visual Detection Sensor and TrueMapping Distance Sensor with a clean cloth, and avoid using any detergent or cleaning spray.



Before using the product on a rug with tasseled edges, please fold the rug edges under.



Please do not stand in narrow spaces, such as hallways, and make sure not to block the Detection Sensor.

### 3. Operating and Programming/3.2 Quick Start

#### 1 Remove Protective Strips and Films

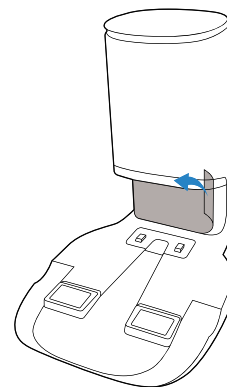
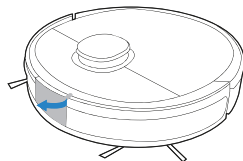
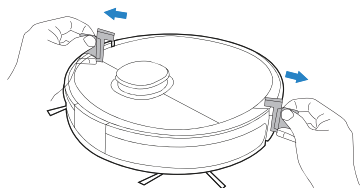

#### 2 Connect Power Cord

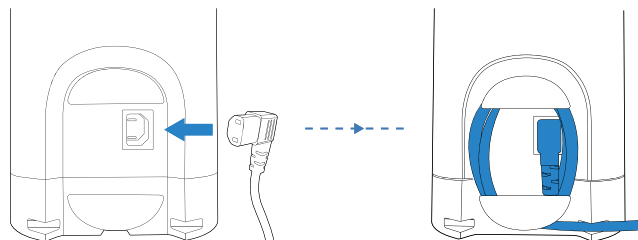

#### 3 Install Side Brushes

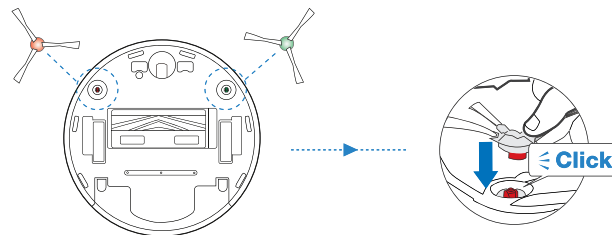

# 3. Operating and Programming/3.3 Charging DEEBOT

## 1 Auto-Empty Station Placement

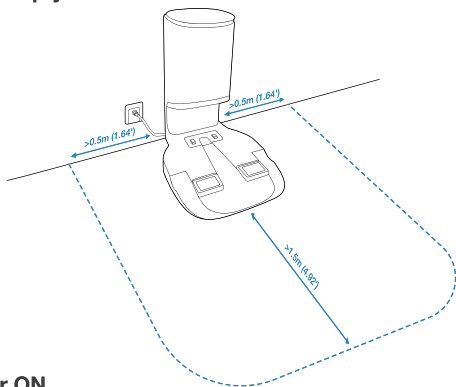

## 2 Power ON

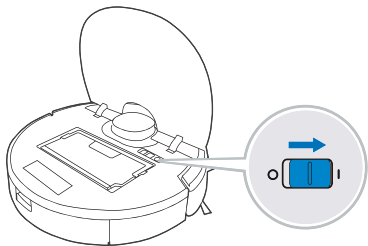



**Note:** I = ON, O = OFF.

**!** DEEBOT cannot be charged when being powered OFF.

## 3 Charge DEEBOT

Empty remaining water from the Reservoir and remove the Reservoir and the Cleaning Cloth Plate before charging DEEBOT.

 flashes when DEEBOT is charging.  goes out when DEEBOT is fully charged.

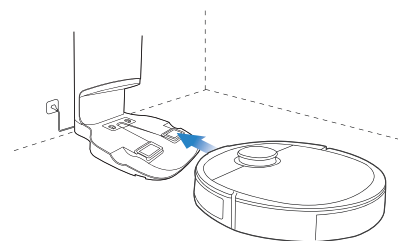

- \* When Auto-Empty Station is connected to power, DEEBOT automatically returns to the station to charge and empty the Dust Bin as it needs.
- \* Make sure DEEBOT starts cleaning from the Auto-Empty Station to help DEEBOT return to charge successfully.

### 3. Operating and Programming/3.4 ECOVACS HOME App

To enjoy all available features, it is recommended to control your DEEBOT via the ECOVACS HOME app.

**Before you start, make sure that:**

- Your mobile phone is connected to a Wi-Fi network.
- The 2.4GHz band wireless signal is enabled on your router.
- The Wi-Fi indicator light on DEEBOT is slowly flashing.



**Wi-Fi Indicator Light**

	Slowly flashing	Disconnected to Wi-Fi or waiting for Wi-Fi connection
	Rapidly flashing	Connecting to Wi-Fi
	Solid	Connected to Wi-Fi

**Tips:**

If you have any problems during the Wi-Fi setup process, refer to the Troubleshooting > Wi-Fi Connection section in this manual.



### 3. Operating and Programming/3.5 Operating DEEBOT

During the first cleaning, please supervise DEEBOT and assist it should there be a problem.

#### 1 Start

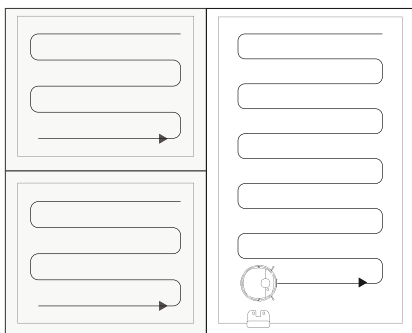
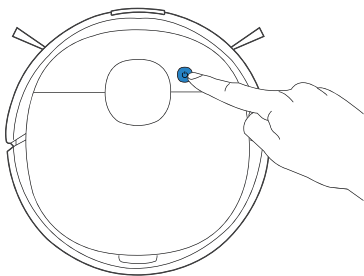

#### 2 Pause

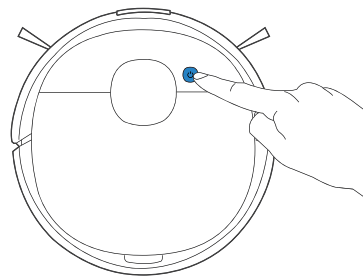

#### 3 Wake Up

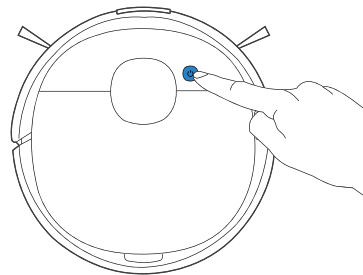

**Note:** The robot's Control Panel stops glowing after the robot is paused for a few minutes. Press the AUTO Mode Button on DEEBOT to wake up the robot.

#### 4 Return to Charge

Pressing  for 3 seconds to send DEEBOT back to the Docking Station.

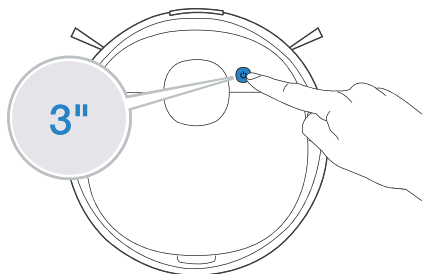

#### 1 Remove the Pre-installed OZMO Mopping System

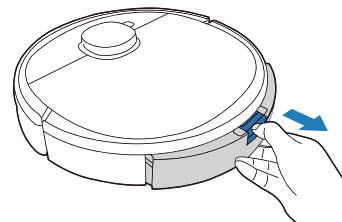

#### 2 Add Water

- \* To prolong the service life of OZMO Pro, it is recommended to use purified water or softened water.
- \* Do not soak OZMO Pro in water.

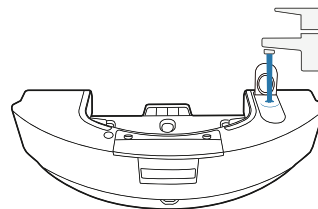

## 3. Operating and Programming

### /3.6 OZMO Pro Oscillating System

#### Note:

1. With electric oscillating mopping up to 480 times per minute, OZMO Pro is applicable for areas of highly concentrated dirt or dust.
2. Before installing OZMO Pro, please make sure the contacts are thoroughly dry.
3. Please avoid using OZMO Pro on the carpet.

### 3 Attach Disposable Cleaning Cloth

\* Please **only attach the Disposable Cleaning Cloth** to OZMO Pro. The Washable/Reusable Microfiber Cleaning Cloth is not compatible with OZMO Pro.

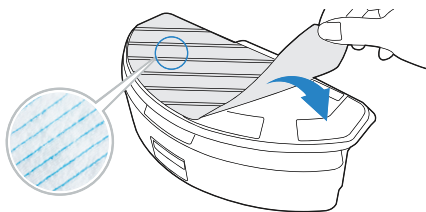

### 5 Install OZMO Pro

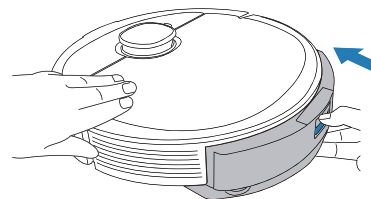

### 4 Dry Contacts Thoroughly

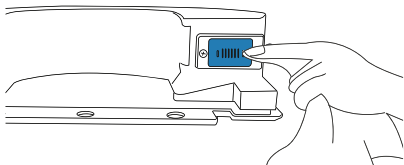

### 6 Start Mopping

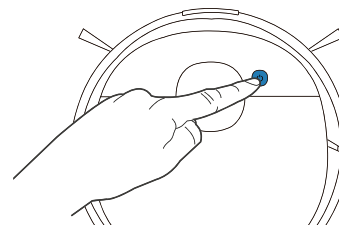

### 3. Operating and Programming/3.7 OZMO Mopping System

1 **Note:** To prolong the service life of the reservoir, it is recommended to use purified water or softened water for OZMO mopping system.

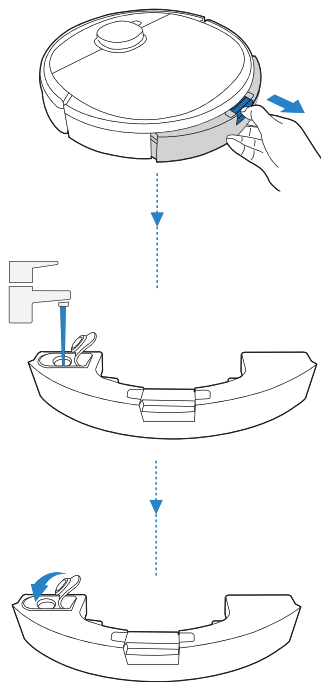

2 **Note:** When DEEBOT is mopping, DEEBOT automatically detects the carpet and keeps away from it. If you need to clean the carpet, please uninstall the cleaning cloth plate first.

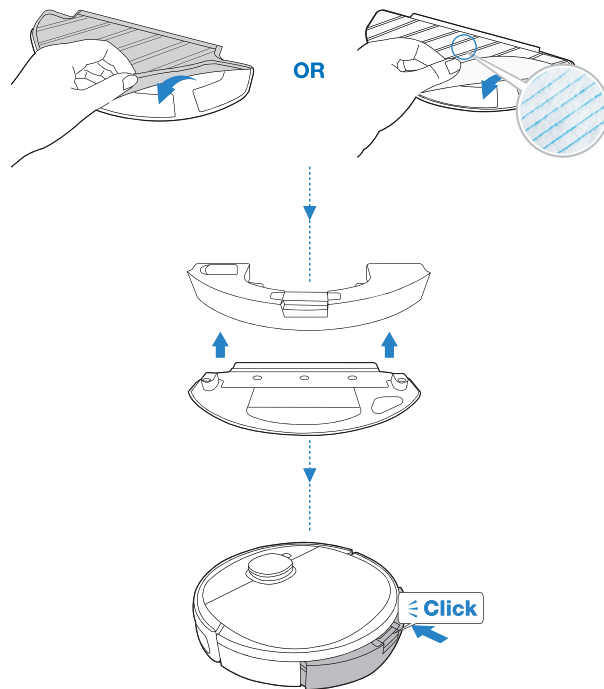

## 4. Maintenance/4.1 Regular Maintenance

To keep DEEBOT running at peak performance, perform maintenance tasks and replace parts with the following frequencies:

Robot Part	Maintenance Frequency	Replacement Frequency
Disposable Cleaning Cloth	After each use	Replace after each use
Washable/Reusable Microfiber Cleaning Cloth	After each use	Every 50 washes
Dust Bag	/	Dust Bags should be replaced when prompted by the ECOVACS HOME App.
OZMO Mopping System	After each use	/
Side Brush	Once every 2 weeks	Every 3-6 months
OZMO Pro Oscillating System	After each use	/
Main Brush	Once per week	Every 6-12 months
Sponge Filter/ High Efficiency Filter	Once per week	Every 3-6 months
AIVI Visual Detection Sensor Universal Wheel Anti-Drop Sensors Bumper Charging Contacts Auto-Empty Station Pins	Once per week	/

**Before performing cleaning and maintenance tasks on DEEBOT, turn the robot OFF and unplug the Docking Station. A multi-function Cleaning Tool is provided for easy maintenance. Handle with care, this cleaning tool has sharp edges.**

**Note:** ECOVACS manufactures various replacement parts and fittings. Visit <https://www.ecovacs.com/global> for more information to purchase accessory replacements.

## 4. Maintenance/4.2 OZMO Pro Oscillating System and OZMO Mopping System

### OZMO Pro Oscillating System

- 1 \* After DEEBOT finishes mopping, please empty the reservoir.

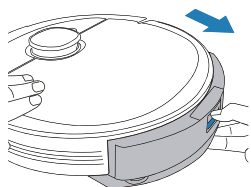

- 2 \* For a proper maintenance, wipe OZMO Pro with a clean dry cloth. Do not rinse OZMO Pro into water.

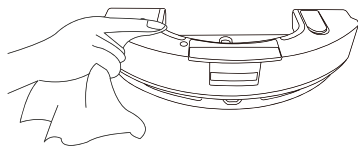

### OZMO Mopping System

1

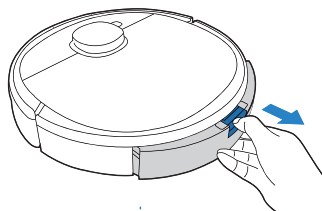

2

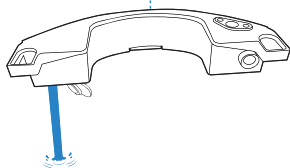

3

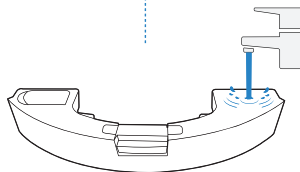

4

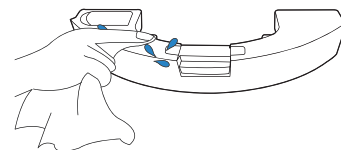

- ! Clean the water inlet filter on the bottom of the Reservoir if it is clogged.

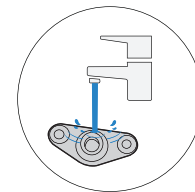
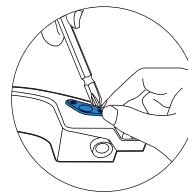

## 4. Maintenance/4.2 OZMO Pro Oscillating System and OZMO Mopping System

### 5 Washable/Reusable Microfiber Cleaning Cloth

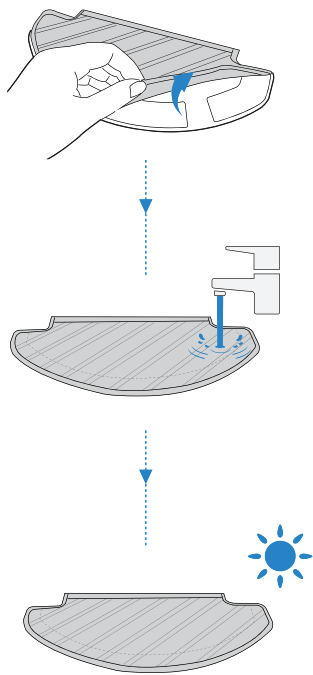

### Disposable Cleaning Cloth

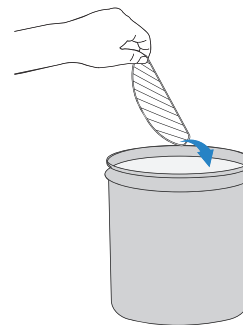

## 4. Maintenance/4.3 Auto-Empty Dust Bin and Filters

### Dust Bin

1

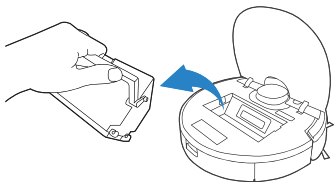

2

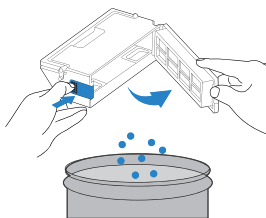

3

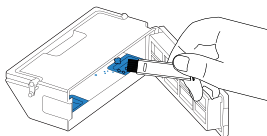

### Filter

1

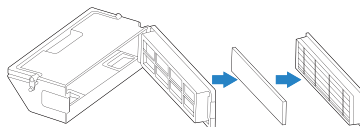

2

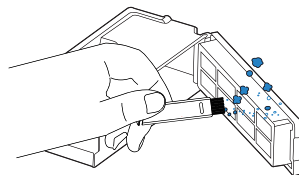

3



4

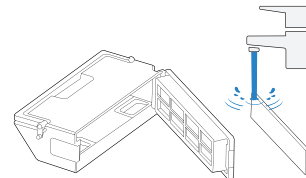

5

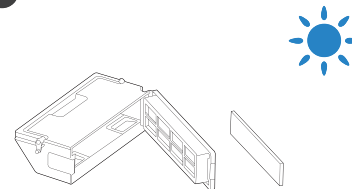



## 4. Maintenance/4.4 Main Brush and Side Brushes

### Main Brush

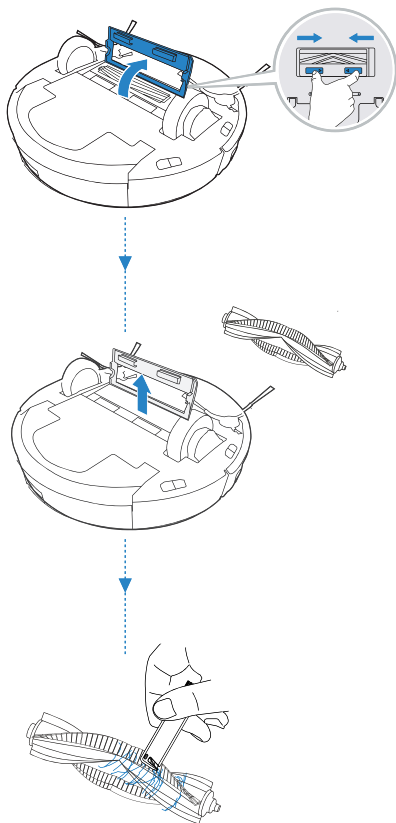

### Side Brushes

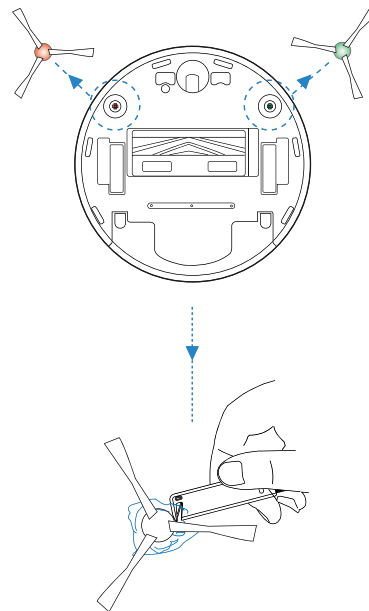

## 4. Maintenance/4.5 Other Components

**Note:** Before cleaning the robot's Charging Contacts and Auto-Empty Station Pins, turn the robot OFF and unplug the Auto-Empty Station. Clean the AIVI Visual Detection Sensor and TrueMapping Distance Sensor with a clean dry cloth, and avoid using any detergent or cleaning spray.

1

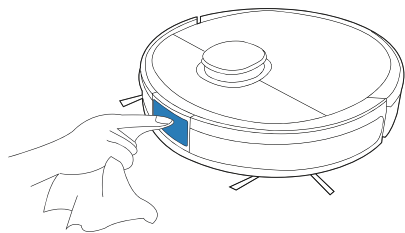

2

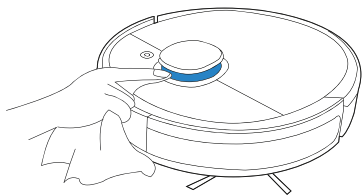

3

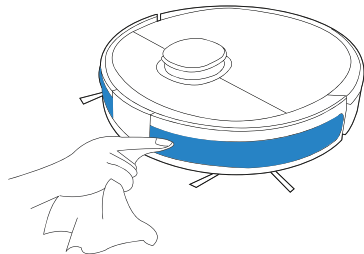

4

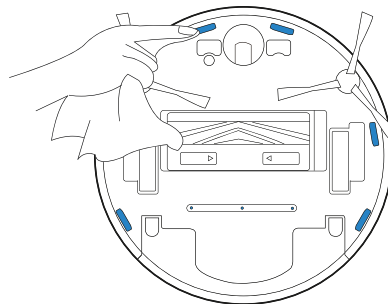

5

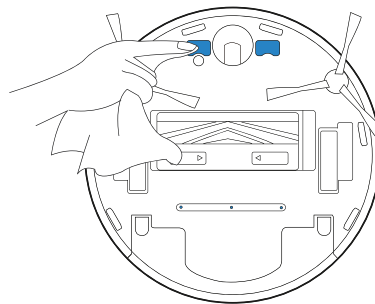

6

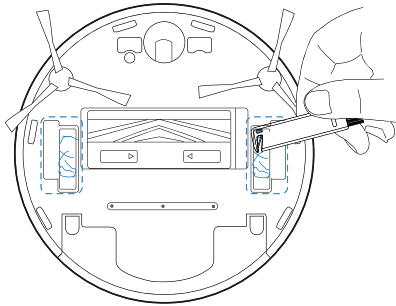

8

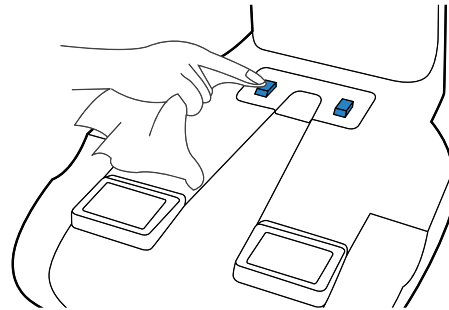

7

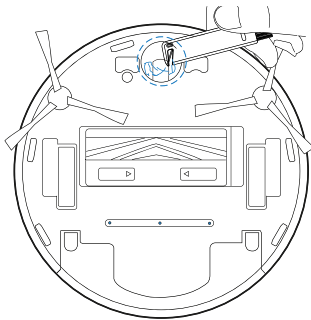

9

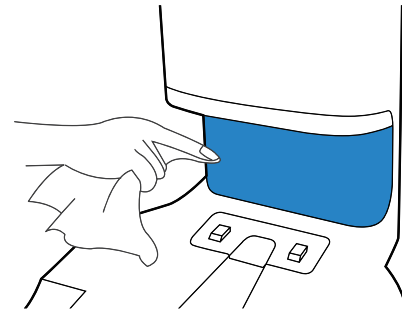

## 4. Maintenance/4.6 Dust Bag

### 1 Dispose of the Dust Bag

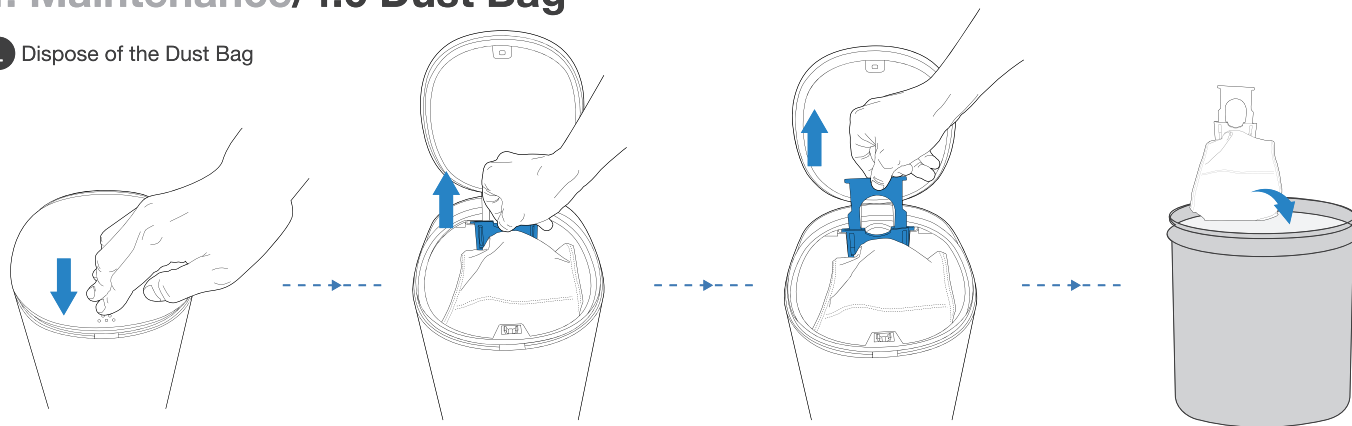

\* The Dust Bag will be sealed by the handle so the dust will not leak.

### 2 Clean the Blower Cover

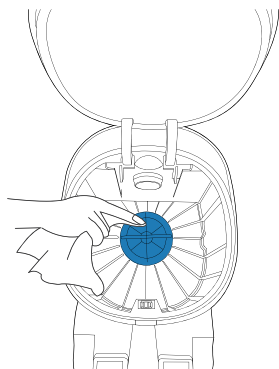

### 3 Install the Dust Bag

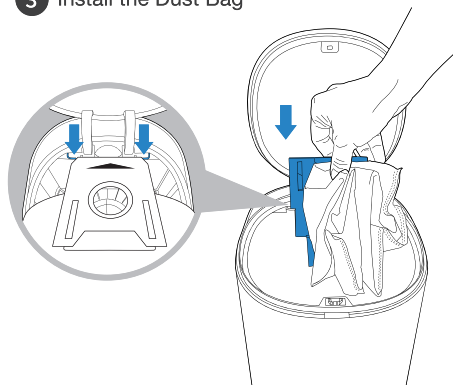

### 4 Close the Dust Container Lid

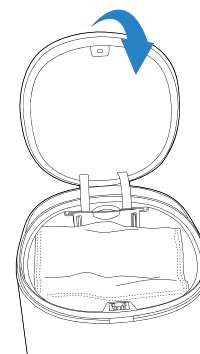

## 4. Maintenance/4.7 Dust Evacuation Tube

Unscrew the Dust Evacuation Tube Cover

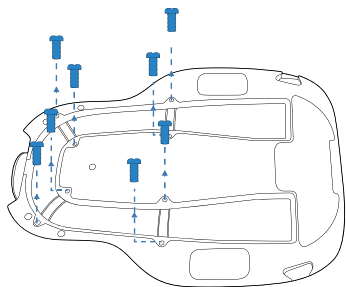

Uninstall the Dust Evacuation Tube Cover

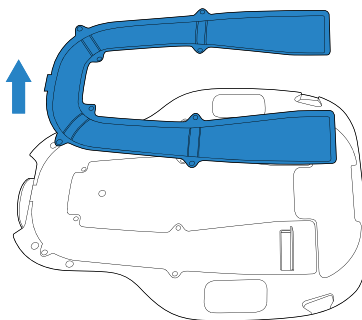

Clean the Dust Evacuation Tube

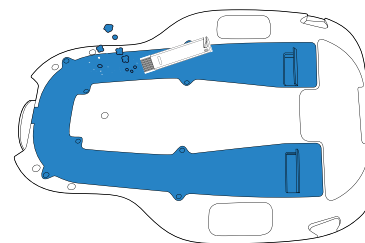

## 4. Maintenance/4.8 Storage

If DEEBOT will not be used for a while, fully charge DEEBOT and power OFF before storage. Charge DEEBOT every 1.5 month to prevent battery drain.

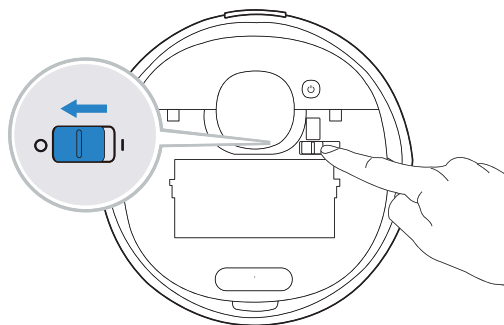

**Note:** When DEEBOT is not cleaning, it is recommended to keep DEEBOT powered ON and charging.

## 5. Status Indicator

The light effect of the Status Indicator on Auto-Empty Station corresponds to different states and solutions. For more support, please refer to the Troubleshooting Section of this manual.

Light Effect	Status	Solutions
Indicator light off	The Auto-Empty Station is in standby.	/
	DEEBOT is in Do Not Disturb Mode.	/
Glowing a solid WHITE	DEEBOT returns to the Auto-Empty Station and starts to Auto-Empty.	/
	DEEBOT is Auto-Emptying.	/
	The Auto-Empty Station's suction power decreased.	Please check the Dust Bag.
Glowing a solid RED	The Dust Bag is not installed.	Please install the Dust Bag.
	The Auto-Empty Station failed to Auto-Empty the dust.	Please check the solution in the App.
	The Dust Container Lid is not closed.	Please make sure the Dust Container Lid is firmly closed.

## 6. Troubleshooting/6.1 Troubleshooting

No.	Malfunction	Possible Causes	Solutions
1	DEEBOT is not charging.	DEEBOT is not switched ON.	Switch ON DEEBOT.
		DEEBOT has not connected to the Docking Station.	Be sure that the robot's Charging Contacts have connected to the Docking Station Pins.
		The Power Cord is not connected to the Docking Station.	Make sure the Power Cord is firmly connected to the Docking Station.
		The Docking Station is not connected to the power supply.	Make sure the Docking Station is connected to the power supply.
		The battery is completely discharged.	Please contact Customer Care for help.
2	DEEBOT cannot return to the Docking Station.	The Docking Station is not correctly placed.	Refer to section 3.2 to correctly place the Docking Station.
		The Docking Station is not correctly connected.	Make sure the Docking Station is correctly connected.
		The Docking Station is manually moved during the cleaning.	It is suggested not to move the Docking Station during the cleaning.
		DEEBOT is paused for more than 90 minutes.	It is suggested not to pause DEEBOT for more than 90 minutes.
		DEEBOT did not start cleaning from the Docking Station.	Make sure DEEBOT starts cleaning from the Docking Station.
3	DEEBOT gets stuck while working and stops.	DEEBOT is tangled with something on the floor (electrical wires, curtains, carpet fringing, etc.).	DEEBOT will try various ways to free itself. If it is unsuccessful, manually remove the obstacles and restart.
		DEEBOT might be stuck under furniture with an entrance of similar height.	Please set a physical barrier, or set a Virtual Boundary in the ECOVACS Home App.



No.	Malfunction	Possible Causes	Solutions
4	DEEBOT returns to the Docking Station before it has finished cleaning.	Working time varies according to floor surface, room complexity and the Cleaning Mode selected. When the battery gets low, DEEBOT automatically switches to Recharge Mode and returns to the Docking Station to recharge itself.	Turn on Continuous Cleaning function in ECOVACS HOME App. DEEBOT will automatically resume the uncompleted cleaning cycle when Continuous Cleaning is enabled.
		DEEBOT is unable to reach certain areas blocked by furniture or barriers.	Tidy up the area to be cleaned by putting furniture and small objects in their proper place.
		The Docking Station is too distant from the center of the house.	Please place the Docking Station against the wall of a central room of the house.
5	DEEBOT does not clean automatically at the scheduled time.	Time Scheduling function is cancelled.	Program DEEBOT to clean at specific times using the ECOVACS Home App.
		DEEBOT is switched OFF.	Switch ON DEEBOT.
		The robot's battery is low.	Keep DEEBOT switched ON and connected to the Docking Station to make sure it has a full battery to work at any time.
6	The water is not coming out of the Reservoir when DEEBOT is mopping.	The water inlet filter on the bottom of Reservoir is clogged.	Unscrew the water inlet on the bottom of Reservoir and clean the filter as described in Section 4.1.
		The Reservoir runs out of water.	Add water into the Reservoir.
		The water outlets on the bottom of DEEBOT are clogged.	Check the water outlets on the bottom and clean.

No.	Malfunction	Possible Causes	Solutions
7	DEEBOT misses cleaning spots to be cleaned, or repeats cleaning the area cleaned.	The cleaning cycle is interfered by small objects or barriers on the floor.	Remove power cords and small objects from the floor to ensure cleaning efficiency. DEEBOT will automatically clean the area missed, please avoid moving DEEBOT manually or block the path during the cleaning cycle.
		DEEBOT is working on slippery polished floors.	Make sure the floor wax is dried before DEEBOT starts cleaning.
		DEEBOT is unable to reach certain areas blocked by furniture or barriers.	Tidy up the area to be cleaned by putting furniture and small objects in their proper place.
		The TrueMapping Distance Sensor is blocked.	Remove the objects that are blocking the TrueMapping Distance Sensor.
8	DEEBOT is making too much noise when cleaning.	DEEBOT is tangled or blocked with debris.	Clean DEEBOT as described in section 4 Maintenance and restart. If the trouble persists, please contact Customer Care.
9	AIVI Visual Detection Sensor cannot recognize objects.	The cleaning area is not well illuminated.	Smart Recognition requires sufficient lighting. Please make sure the areas to be cleaned are well illuminated.
		AIVI Visual Detection Sensor lens is dirty or blocked.	Clean the lens with a clean soft cloth, and make sure the sensor is not blocked. Avoid using any detergent or cleaning spray while cleaning.
		The objects are too close to the AIVI Visual Detection Sensor.	This is normal. The optimal distance of object identification for AIVI Visual Detection Sensor is 50 cm(19.7 inches).

No.	Malfunction	Possible Causes	Solutions
10	DEEBOT is not able to connect to the home Wi-Fi network.	Incorrect home Wi-Fi username or password entered.	Enter the correct home Wi-Fi username and password.
		Incorrect App installed.	Please download and install ECOVACS Home App.
		DEEBOT is not within range of your home Wi-Fi signal.	Make sure DEEBOT is within range of your home Wi-Fi signal.
		Network setup started before DEEBOT was ready.	Turn ON Power Switch. Press the RESET Button. DEEBOT is ready for network setup when its Wi-Fi Indicator light flashes slowly.
		DEEBOT does not support 5 GHz Wi-Fi.	Make sure the robot has been connected with 2.4 GHz Wi-Fi network.
11	DEEBOT does not clean the whole area.	The cleaning area is not tidy.	Remove small objects from the floor and tidy up the cleaning area before DEEBOT starts cleaning.
12	DEEBOT reservoir drops out of place during use.	The reservoir is not correctly installed.	Make sure DEEBOT reservoir clicks into place when installing.
13	DEEBOT Side Brushes drop out of place during use.	The Side Brushes are not correctly installed.	Make sure the Side Brushes click into place when installing.
14	DEEBOT loses the map.	Manually picking up DEEBOT might cause the map loss.	When there's a map generated, if DEEBOT loses the map, place DEEBOT on the Docking Station and the map will be recovered.

No.	Problem	Possible Cause	Solution
15	DEEBOT does not start auto-emptying after returning to the Auto-Empty Station.	The Dust Container Lid is not closed.	Close the Dust Container Lid.
		The Dust Bag is not installed to the Auto-Empty Station.	Install the Dust Bag and close the Dust Container Lid.
		Manually move DEEBOT to the Auto-Empty Station will not trigger Auto-Emptying.	In order to make sure DEEBOT starts auto-emptying successfully, avoid picking up and moving the Auto-Empty Station during the cleaning.
		DEEBOT returns to the Auto-Emptying Station running Video Manager in the App.	This is normal.
		Do Not Disturb mode is enabled in ECOVACS HOME App.	This is normal. Disable Do Not Disturb mode in the App, or start auto-emptying manually.
		The Auto-Emptying efficiency of Auto-Empty Station decreases.	Replace the Dust Bag and close the Dust Container Lid.
		If the possible causes are excluded, it might be a component malfunction.	Please contact customer service.
16	DEEBOT fails to auto-empty the Dust Bin.	The Auto-Empty Dust Bin is not installed.	Please install the Auto-Empty Dust Bin with two Auto-Empty Outlets on the bottom.
		The Auto-Emptying efficiency of Auto-Empty Station decreases.	Replace the Dust Bag and close the Dust Container Lid.
		The Auto-Empty Outlets on the Auto-Empty Dust Bin is stuck by debris.	Uninstall the Auto-Empty Dust Bin and clean the debris on the Auto-Empty Outlets.
		Dust Evacuation Tube is blocked.	Clean the Dust Evacuation Tube.
17	There is debris in the Dust Container.	Fine particles are absorbed inside the Dust Container through the Dust Bag.	Clean the Dust Container Lid and inner wall.
		The Dust Bag is damaged.	Check the Dust Bag and replace it.

No.	Problem	Possible Cause	Solution
18	DEEBOT leaks dust or debris while cleaning.	The Auto-Empty Outlets are stuck by debris.	Uninstall the Auto-Empty Dust Bin and clear the debris.
19	The Base is dirty.	Main Brush has debris on it and requires cleaning.	Clean the Main Brush.

## 6. Troubleshooting/6.2 Wi-Fi Connection

Before Wi-Fi setup, make sure DEEBOT, mobile phone, and Wi-Fi network meet the following requirements.

### DEEBOT and Mobile Phone Requirements

- DEEBOT is fully charged and the power switch of DEEBOT is turned on.
- Wi-Fi status light slowly flashes.
- Turn off mobile phone's cellular data (you can turn it back on after setup).

### Wi-Fi Network Requirements

- You are using a 2.4GHz or 2.4/5 GHz mixed network.
- Your router supports 802.11b/g/n and IPv4 protocol.
- Do not use a VPN (Virtual Private Network) or Proxy Server.
- Do not use a hidden network.
- WPA and WPA2 using TKIP, PSK, AES/CCMP encryption.
- WEP EAP (Enterprise Authentication Protocol) is not supported.
- Use Wi-Fi channels 1-11 in North America and channels 1-13 outside North America (refer to local regulatory agency).
- If you are using a network extender/repeater, the network name (SSID) and password are the same as your primary network.

# 7. Product Specifications

For Hong Kong

<b>Model</b>	<b>DBX11-31</b>			
Rated Input	20V $\equiv$ 1A			
<b>Docking Station Model</b>	<b>CH1918</b>		<b>CH1822*</b>	
	Rated Input (Charging)	220-240V $\sim$ 50-60Hz 0.3A	Input	100-240V $\sim$ 50-60Hz 0.5A
	Rated Output	20V $\equiv$ 1A	Output	20V $\equiv$ 1A
	Power (Auto-Emptying)	1000W	/	
Frequency bands	2400-2483.5MHz			
Off Mode Power	Less than 0.50W			
Networked Standby Power	Less than 2.00W			

\* CH1822 is sold separately.

Output power of the Wi-Fi module is less than 100mW.

**Note:** Technical and design specifications may be changed for continuous product improvement.

## For Taiwan

<b>Model</b>	<b>DBX11-31</b>	
Rated Input	20V $\equiv$ 1A	
<b>Docking Station Model</b>	<b>CH1918</b>	
	Rated Input (Charging)	110-120V $\sim$ 50-60Hz 0.5A
	Rated Output	20V $\equiv$ 1A
	Power (Auto-Emptying)	1000W
Frequency bands	2412-2462MHz	

Output power of the Wi-Fi module is less than 100mW.

**Note:** Technical and design specifications may be changed for continuous product improvement.



感謝您選購科沃斯 DEEBOT 機器人！希望它能在未來的多年中都讓您感到滿意。我們相信新主機將能幫您保持家居衛生，讓您節省更多時間，做您自己想做的事情。

智生活，享人生。

如遇根據本說明手冊無法妥善解決之問題，請與我們的客服中心聯繫，相關技術人員將會解答您的具體疑問或問題。

如需更多資訊，請訪問科沃斯機器人官網：[www.ecovacs.com](http://www.ecovacs.com)

本公司保留對本產品進行技術和 / 或設計更改以持續改進的權利。

**感謝您選擇 DEEBOT !**

# 目錄

1. 安全規範 .....	43
2. 產品組成 .....	45
3. 產品使用 .....	50
4. 部件保養 .....	57
5. 狀態指示燈 .....	67
6. 常見問題 .....	68
7. 產品參數 .....	74

# 1. 安全規範

## 重要安全說明

使用本電氣設備時，請務必終始遵循基本預防措施，包括以下注意事項：

### 使用產品前請詳閱操作手冊，並妥善保管。

1. 肢體不健全、精神有障礙及缺乏相關經驗和知識的人 (包括兒童) 必須在監護人的監督及指導下使用本產品。
2. 請照看好兒童，本產品不能用於玩耍。
3. 針對產品在清掃中可能出現的問題，應及早排除。清理地面上的電源線和細小物品避免產品在清潔過程中受阻。將地毯的邊緣翻摺到地毯下，並使垂掛的窗簾、桌布等不要接觸地面。
4. 若存在諸如樓梯等懸空環境，請先測試產品看其是否可以檢測到懸空區域邊緣而不跌落。應在懸空區域邊緣設置防護欄以防產品跌落。應確保該防護設施不會引發絆倒等人身傷害。
5. 請按照說明書的指示使用產品。僅可使用原廠推薦或銷售的配件。
6. 確保電源電壓符合集塵座上的標示電壓。
7. 僅在室內家庭環境中使用。請勿在室外、商業及工業場所使用。
8. 僅可使用原廠充電電池及集塵座。嚴禁使用不可充電電池，電池規格信息請參考「技術參數」。
9. 使用產品前確保塵盒、過濾材料已安裝到位。
10. 禁止在有明火或易碎物品的環境中使用產品。
11. 禁止在極熱 (高於 40°C) 或極冷 (低於 -5°C) 的環境中使用產品。
12. 產品工作時，請看管好兒童和寵物。禁止人體的頭髮，衣服，手指等其他部位靠近產品的開口和運作部件。
13. 請勿在嬰幼兒睡眠的房間內使用產品。
14. 禁止在潮濕或有積水的地面上使用產品。
15. 禁止產品吸取諸如石子，廢紙等任何可能堵塞產品的物品。
16. 禁止產品吸取任何易燃物品，如汽油、影印機或復印件用調色劑和色粉。禁止在有易燃物品的清潔區域中使用產品。
17. 禁止產品吸取任何正在燃燒的物品，如香煙、火柴、灰燼及其它可能導致火災的物品。
18. 禁止在吸口處放置物品。吸口堵塞時請勿使用產品。清理吸口處的灰塵，棉絮，毛髮等，確保吸口處空氣流通順暢。
19. 小心使用電源線避免其損壞。禁止利用電源線拖曳或拉扯產品及產品集塵座，禁止將電源線作為提把使用，禁止把電源線夾在門縫中，禁止在尖銳或彎角處拉扯電源線。禁止產品在電源線上運行，同時電源線應遠離熱源。
20. 如果電源線軟線損壞，為避免危險，必須由製造商、其維修部或類似部門的專業人員更換。
21. 禁止使用損壞的集塵座。
22. 請勿利用損壞的電源線或電源插座使用產品。當產品或集塵座因跌落、損壞、室外使用或進水致使無法正常運作時，請勿使用。

23. 為避免傷害，產品應由製造商或其售後服務進行維修。
24. 在清潔和維護產品前請先關閉產品開關。清潔和維護集塵座前，請先將插頭自電源插座拔出。
25. 丟棄產品前，請先將產品自集塵座取下，關閉產品電源並取出電池。
26. 在廢棄產品前，必須遵循當地法律法規移除並廢棄產品電池。
27. 請遵循當地法律法規處理舊電池。
28. 即使在產品已嚴重受損的情況下也禁止焚燒產品，產品電池可能因此引發爆炸。
29. 若長時間不使用集塵座，請將集塵座斷電。
30. 請依照本說明書的指示使用產品。因不當使用導致的任何損失及傷害，本公司概不負責。
31. 產品電池僅可由專業人士進行更換。若需更換電池，請與客服人員聯絡。
32. 若長時間不使用產品，請關閉主機電源存放，並拔除充電站電源。
33. 警告：若要是為電池充電，僅可使用本產品隨附的外接式供電裝置 CH1918 或作為配件另行購買的 CH1822 電源 (充電站)。(適用香港)
34. 警告：若要是為電池充電，僅可適用本產品隨附的外接式供電裝置 CH1918。(適用台灣)

## 低功率電波輻射性電機管理辦法

### 第十二條

經型式認證合格之低功率射頻電機，非經許可，公司、商號或使用者均不得擅自變更頻率、加大功率或變更原設計之特性及功能。

### 第十四條







低功率射頻電機之使用不得影響飛航安全及干擾合法通信；經發現有干擾現象時，應立即停用，並改善至無干擾時方得繼續使用。

前項合法通信，指依電信法規定作業之無線電通信。

低功率射頻電機須忍受合法通信或工業、科學及醫療用電波輻射性電機設備之干擾。

設備名稱：掃地機器人 型號：DBX11-31						
單元	限用物質及其化學符號					
	鉛 (Pb)	汞 (Hg)	鎘 (Cd)	六價鉻 (Cr <sup>+6</sup> )	多溴聯苯 (PBB)	多溴二苯醚 (PBDE)
硬膠件	○	○	○	○	○	○
軟膠件	○	○	○	○	○	○
五金件	-	○	○	○	○	○
電子元器 件	-	○	○	○	○	○

備考 1. “○” 係指該項限用物質之百分比含量未超出百分比含量基準值。  
備考 2. “-” 係指該項限用物質為排除項目。

	II 類
	短路防護安全隔離變壓器
	交換式電源供應器
	供室內使用
	直流電
	交流電



R38434  
RoHS

公司名稱：聯強國際股份有限公司  
地址：台北市民生東路三段 75 號 4 樓  
電話：02-25063320

## 2. 產品組成 / 2.1 包裝內容物

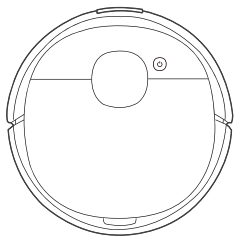

主機

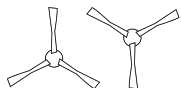

邊刷

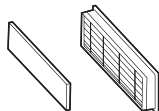

高效過濾組件 + 精細過濾棉

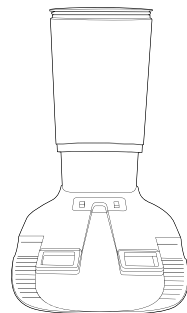

Auto-Empty 集塵座

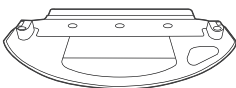

清潔墊底盤

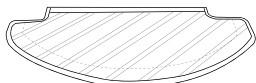

可水洗清潔墊

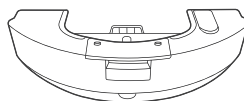

OZMO Pro 電動高頻擦地系統



拋棄式清潔墊

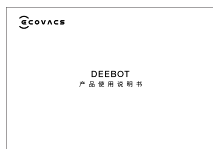

產品使用資料

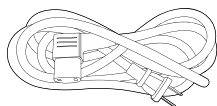

電源線

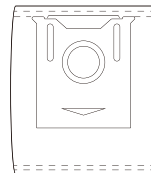

塵袋

\* 本說明書圖示僅供參考，實際外觀請以實物為準。  
產品設計與規格如有變更，恕不另行通知。

## 2. 產品組成 / 2.2 部件名稱

### 機器人正面

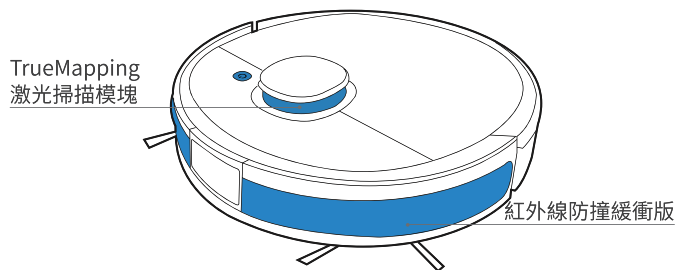
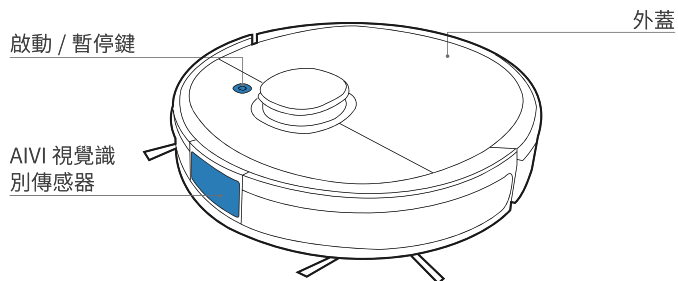

### 機器人內部 (外蓋下方)

#### 重置鍵

配網時：按一下 **C** 鍵，語音提示主機配網。恢復出廠設置：長按 **C** 鍵 5 秒，提示音後，開機音樂響起，主機恢復出廠設置，請謹慎使用。

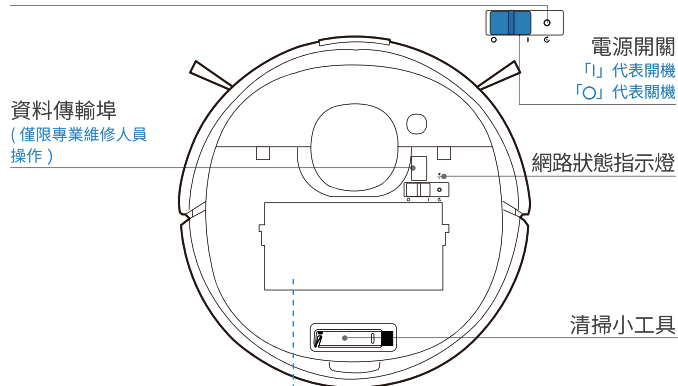

### Auto-Empty 集塵塵盒

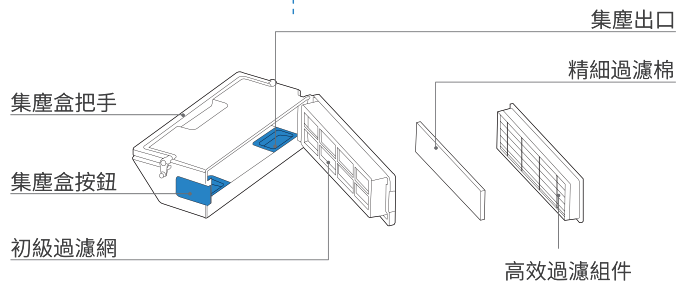

## 機器人背面

充電接收片

地毯感應器

主刷配件

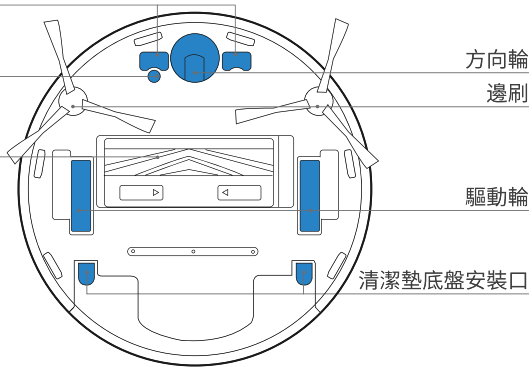

方向輪  
邊刷

驅動輪

清潔墊底盤安裝口

防摔落感應器

主刷配件釋放鍵

水箱

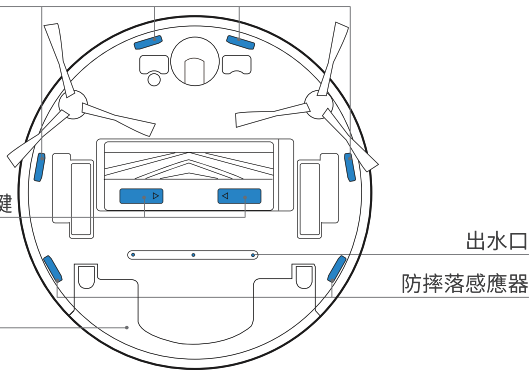

出水口

防摔落感應器

## Auto-Empty 集塵座

集塵座外蓋  
釋放鍵

狀態指示燈

信號發射器

自動集塵入口

充電接收片

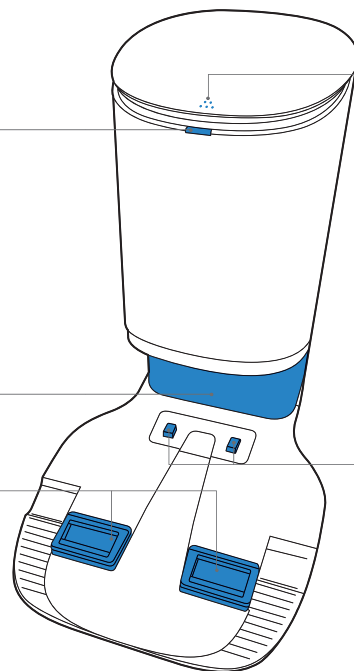



## Auto-Empty 集塵座 (背面)

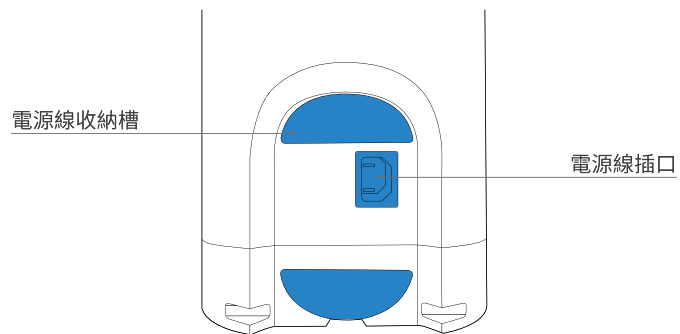

## 底座 (底部)

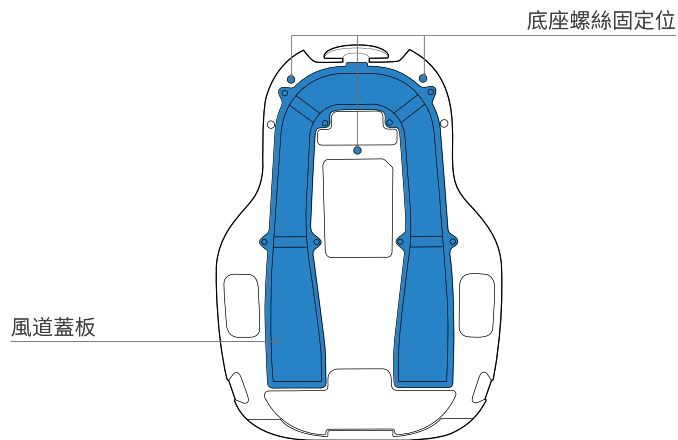

## Auto-Empty 集塵座 (打開外蓋)

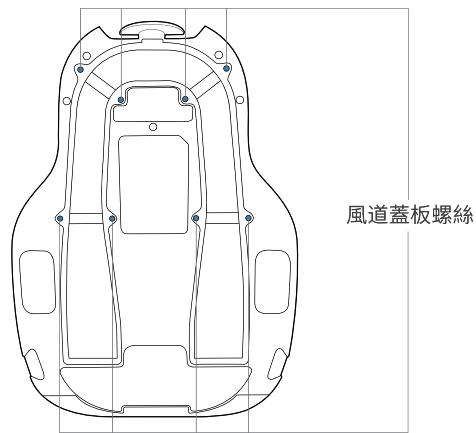
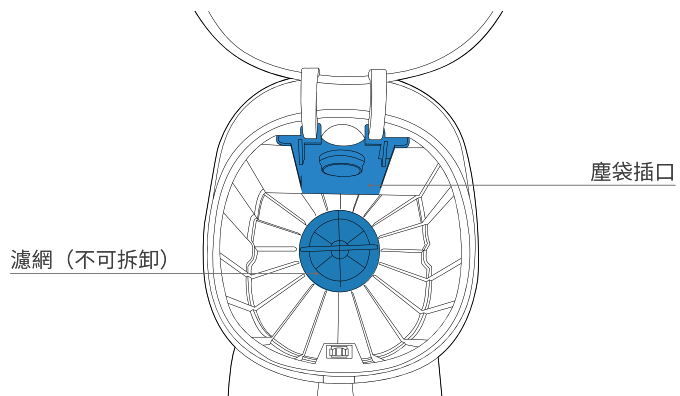

## 塵袋

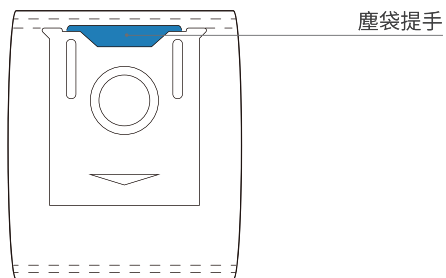

## OZMO Pro 電動高頻擦地系統

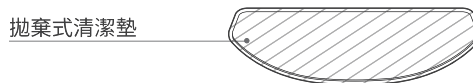
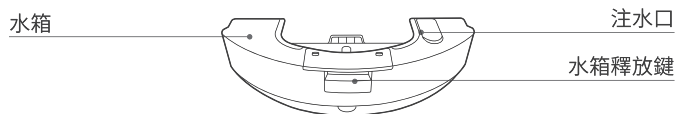

\* OZMO Pro 電動高頻擦地系統需與拋棄式清潔墊配套使用，請勿粘貼可水洗清潔墊。

## 電控水箱及清潔墊組件

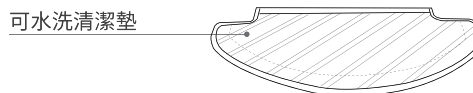
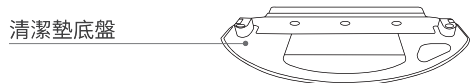

## 電源線

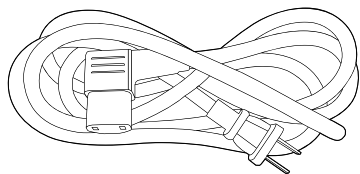

## 3. 產品使用 / 3.1 注意事項

### 整理待清掃空間

使用前，請將桌椅等家具、落地扇等物品擺放整齊，收納好體重記等低矮物品，整理出最大的清掃空間。

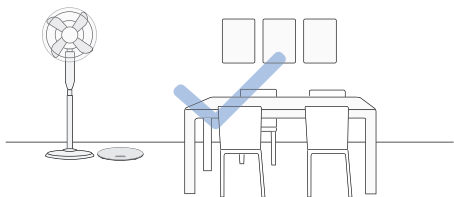

整理地板上的物品，例如電線、清潔墊、拖鞋等雜物，避免影響機器人運作。



如家中地毯有流蘇邊，請提前將邊緣收整入地毯下方。  
\* 請勿在地毯上使用拖地功能。

### 打開房門，幫助主機探索

為更好地幫助 DEEBOT 探索整個空間、建立家居地圖，首次使用前請打開各個房間的房門。

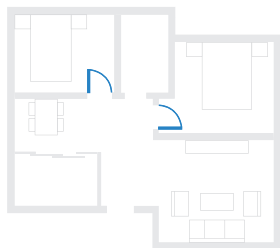

### 預防機器人摔落

若機器人在複合式樓梯口、臺階邊緣等處清掃，請放置防護欄，確保其安全與運作順暢。

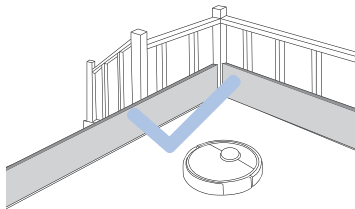

### 營造明亮的清掃環境

主機通過 AIVI 視覺識別傳感器可以識別鞋子、襪子、電線等物品，因此清掃時請確保所有清掃區域處於光線充足的狀態，以免影響主機識別障礙物的效果。

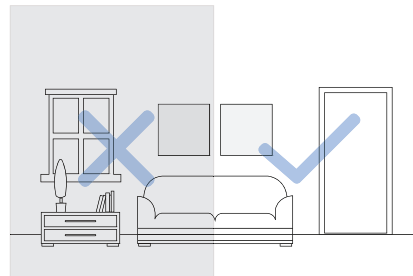

請保障主機視覺的清晰度，注意不要讓主機的 AIVI 視覺識別傳感器鏡片刮蹭或沾附指紋、機油脂類的汙漬。請用乾淨的軟布擦拭，不要使用洗劑、洗衣液、噴霧器。



請避免站在主機前方、門檻和過道等狹窄處，以免主機識別不到待清掃的區域。

## 3. 產品使用 / 3.2 準備工作

### 1 移除防護物

移除主機防護條

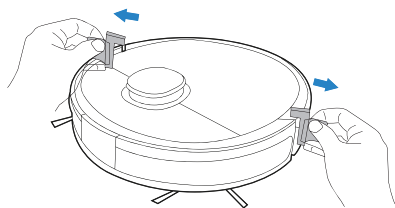

移除視覺傳感器保護膜

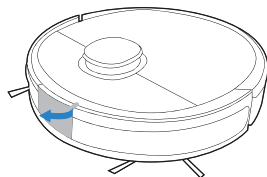

移除集塵座保護膜

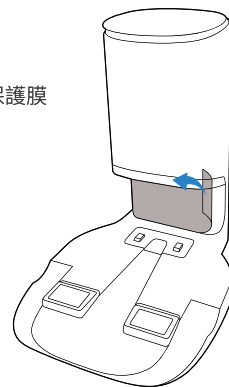

### 2 安裝電源線

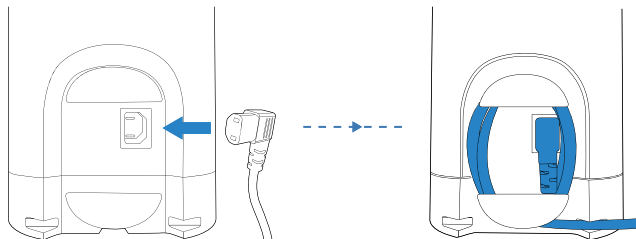

### 3 正確安裝邊刷

注意邊刷上的顏色和卡槽顏色保持一致。

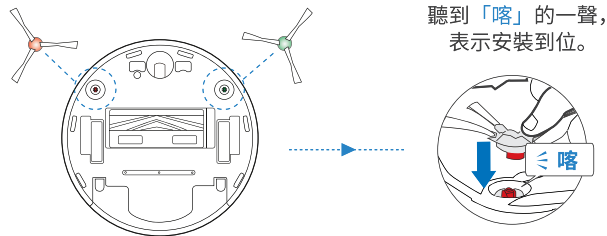

聽到「咯」的一聲，  
表示安裝到位。

### 3. 產品使用 / 3.3 機器人充電

#### 1 找尋適合位置放置集塵座

集塵座靠牆放置在平坦的地面，左右 0.5 公尺和前方 1.5 公尺範圍內不要放置物品。

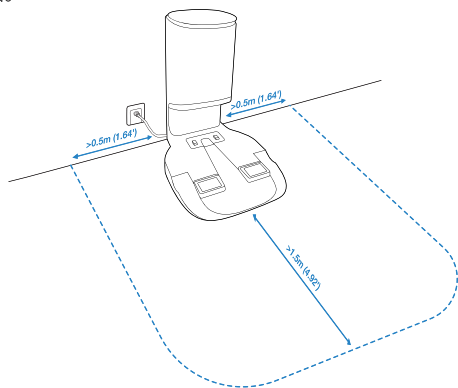

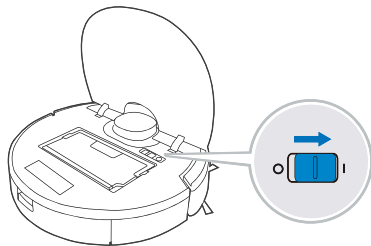

#### 2 開啟機器人電源



\* 「I」為開機，「O」為關機。

! 請注意，主機無法在電源關閉狀態下充電。

#### 3 充電

首次使用時，請打開主機電源開關，將主機放置至集塵座充滿電後啟動，以便主機定位集塵座並順利返回充電。充電時間約為 6.5 小時。充電時，請勿安裝清潔墊組件，保證充電安全、防止潮濕的濕拖清潔墊損壞地板。充電中， 閃爍；充電結束， 熄滅。

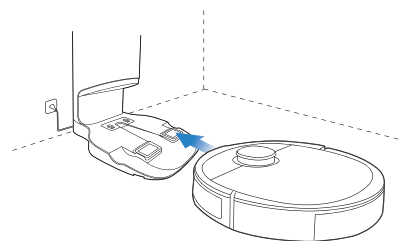

\* 集塵座安裝完畢並連接電源時，主機會在有需要時自動返回充電並清空塵盒。為方便主機完成清掃後能夠順利返回充電，建議主機從自動集塵座出發，清掃過程中請勿搬動自動集塵座。

### 3. 產品使用 /3.4 ECOVACS HOME App

要使用所有可用功能，建議通過 ECOVACS HOME app 控制 DEEBOT。

#### 開始前，請確保：

- 您的手機已連接 Wi-Fi 網路。
- 您的路由器已啓用 2.4GHz 頻段無線信號。
- DEEBOT 上的 Wi-Fi 指示燈緩慢閃爍。



#### Wi-Fi 指示燈

	緩慢閃爍	已斷開 Wi-Fi 連接或正在等待 Wi-Fi 連接
	快速閃爍	正在連接 Wi-Fi
	常亮	已連接 Wi-Fi

#### 提示：

如果在 Wi-Fi 設置過程中遇到任何問題，請參考本手冊中的「故障排除 > Wi-Fi 連接」部分。

### 3. 產品使用 / 3.5 機器人操作

首次建圖時，請跟隨在主機後方幫助排除一些小問題。例如，主機可能會卡在家具低矮處，可以參考以下的方法解決。

- ① 如有條件，可墊高家具；
- ② 遮擋家具底部，不讓主機進入；
- ③ 在 App 中設置虛擬牆，禁止主機進入。

#### 1 啟動清掃

首次開啓清掃工作，請確保產品在集塵座上且充滿電。

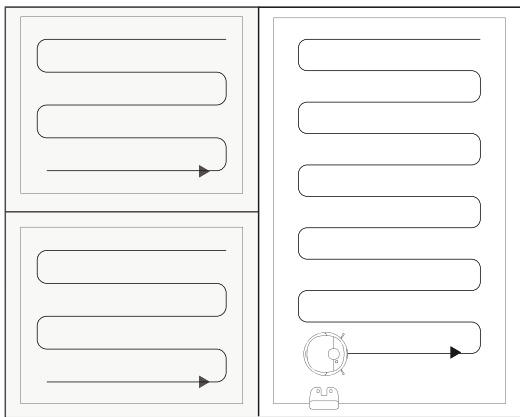

點擊主機  鍵，主機開始按照先沿邊後弓字清掃的方式建立地圖。



#### 2 暫停

主機工作中，短按主機  鍵，即可暫停主機；

#### 3 喚醒

暫停超過 10 分鐘，主機面板所有指示燈熄滅。如需再次啟動工作，請先短按  喚醒主機，待指示燈亮後，再按一次 ，即可啟動主機繼續原來的工作。

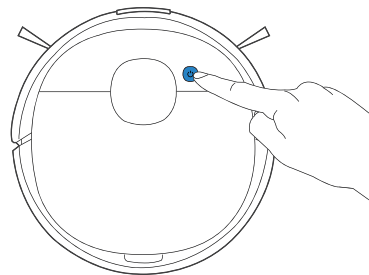

#### 4 返回集塵座

長按  3 秒以上，主機返回集塵座。

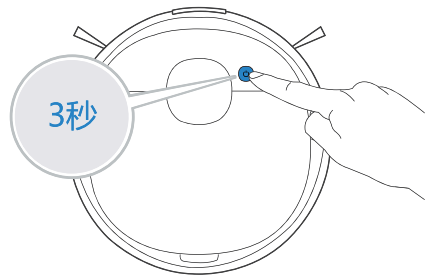

機器人工作結束後，建議不要關機，保持機器人在充電狀態，以便進行下一回合的工作。

### 3. 產品使用 / 3.6 啟動擦地 / 拖地

#### 擦地：選用 OZMO Pro 電動高頻擦地系統

##### 溫馨提示：

1. OZMO Pro 電動高頻擦地系統每分鐘擦地480次，適用於需要深度清潔的區域。
2. 安裝水箱前，請確保水箱接觸片乾燥，以防漏電。
3. 請勿在地毯上使用拖地功能。

#### 1 取下主機預裝的電控水箱組件

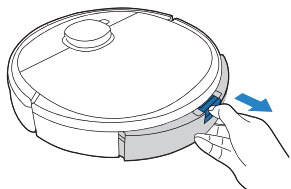

#### 2 粘貼拋棄式清潔墊

- \* OZMO Pro 電動高頻擦地系統需粘貼拋棄式清潔墊以後使用，請勿粘貼可水洗清潔墊。

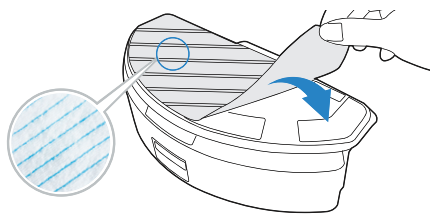

#### 3 加水

- \* 為延長使用壽命，建議使用純淨水或者軟化水。  
\* 請勿將 OZMO Pro 電動高頻擦地系統浸入水中。

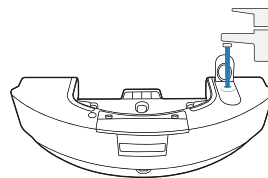

#### 4 確保水箱金屬極片乾燥

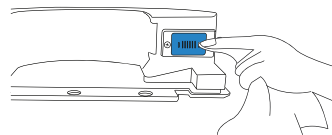

#### 5 安裝 OZMO Pro 電動高頻擦地系統，點擊 開始擦地

- \* 請在 App 中切換拖地模式。

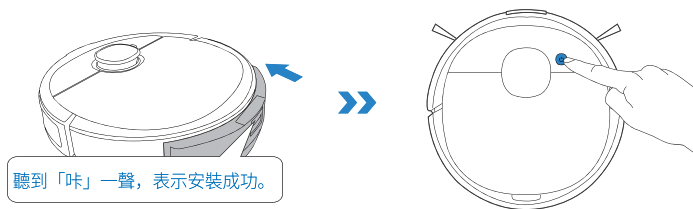



## 拖地：選用電控水箱

### 1 取下水箱

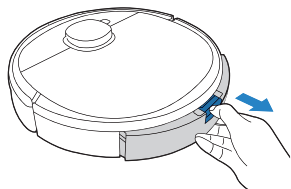

### 2 打開注水口外蓋，注入清水

\* 為延長水箱使用壽命，建議使用純淨水或軟化水。

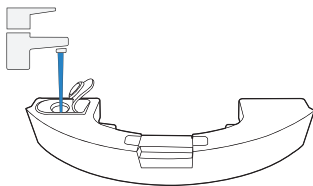

### 3 蓋上注水口外蓋

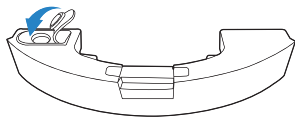

### 4 在清潔墊底盤上粘貼清潔墊

\* 電控水箱可粘貼拋棄式清潔墊或可水洗清潔墊，您可以根據需要選擇適合的清潔墊。

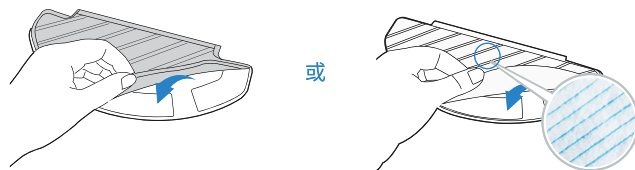

### 5 安裝清潔墊底盤到水箱上

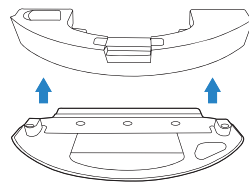

### 6 將水箱組件裝回主機

\* 請勿在地毯上使用拖地功能。  
\* 拖地完成後，請及時處理清潔墊，清空水箱。

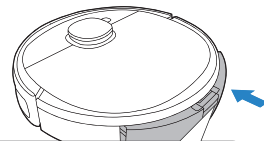

聽到「咔」一聲，表示安裝成功。

## 4. 部件保養 /4.1 維護和保養頻率

為使主機保持巔峰性能，建議參考下錶頻率對主機進行部件維護保養：

部件	維護頻率	更換頻率
拋棄式清潔墊	每次使用後	每次使用後
可水洗清潔墊	每次使用後	每 3 個月
塵袋	/	在 App 提示時進行更換
電控水箱	每次使用後	/
清潔墊底盤	每次使用後	/
OZMO Pro 電動高頻擦地系統	每次使用後	/
邊刷	每 2 周	每 3-6 個月
主刷	每 1 周	每 6-12 個月
精細過濾棉	每 1 周	每 3-6 個月
高效過濾組件	每 1 周	每 3-6 個月
AIVI 視覺識別傳感器 TrueMapping 激光掃描模塊 方向輪 下視感應器 紅外感應防撞板 主機充電極片 集塵座充電極片	每 1 周	/

**小提醒：**保養主機前，請打開主機外蓋，將主機電源開關撥至「○」關機。

如需購買配件，請訪問科沃斯網站：<https://www.ecovacs.com/global>

## 4. 部件保養 / 4.2 OZMO Pro 電動高頻擦地系統、電控水箱

### 清理 OZMO Pro 電動高頻擦地系統

- 1 取下 OZMO Pro 電動高頻擦地系統

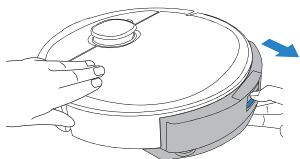

- 2 擦拭

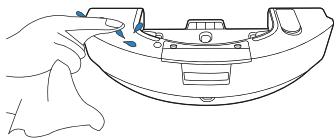

\* 清理 OZMO Pro 電動高頻擦地系統時，請用乾淨的清潔墊擦拭，請勿用水沖洗。

### 清理電控水箱

- 1 按壓水箱釋放鍵，取下水箱

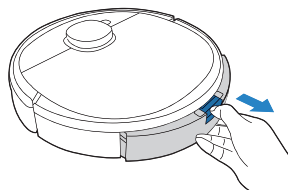

- 2 清空水箱

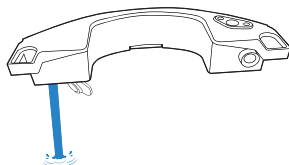

- 3 清洗水箱

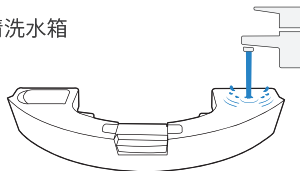

- 4 擦乾或自然晾乾

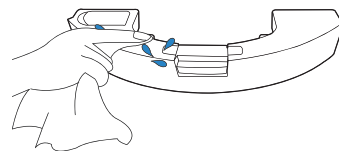

! 若電控水箱出水不均勻、流速過慢，請取下水箱濾網清理。

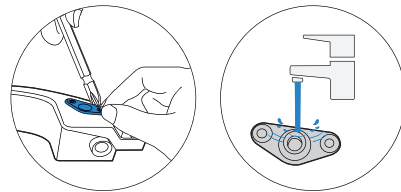

## 清理可水洗清潔墊

- 1 取下可水洗清潔墊

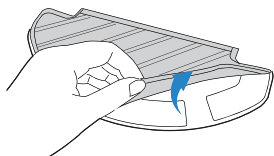

- 2 清洗可水洗清潔墊

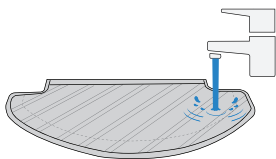

\* 注意不要使用強酸或強鹼性清潔劑。

- 3 晾乾

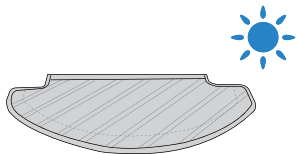

## 清理拋棄式清潔墊

丟棄拋棄式清潔墊

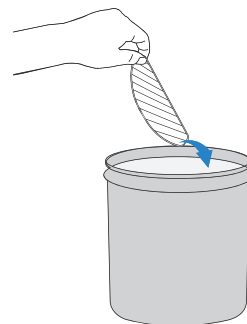

## 4. 部件保養 /4.3 Auto-Empty 集塵塵盒和濾材

### Auto-Empty 集塵塵盒

- 1 掀開機器人外蓋，取出集塵盒。

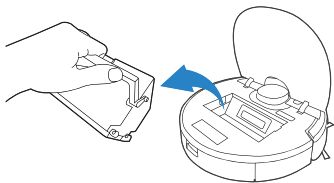

- 2 打開塵盒鎖扣，並傾倒垃圾。

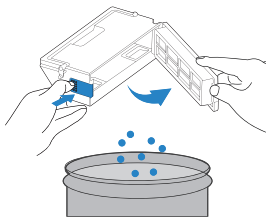

- 3 清理塵盒的集塵出口。

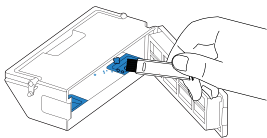

### 濾材

- 1 拆卸精細過濾棉和可水洗高效過濾配件。

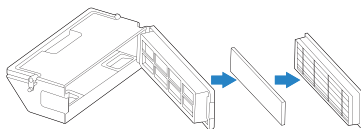

- 2 以清理小工具的毛刷，清潔初級濾網上內外兩面的灰塵。

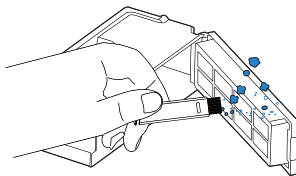

- 3 輕拍高效過濾組件，去除灰塵。

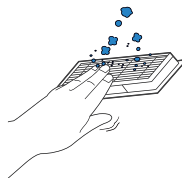

- 4 以水沖洗集塵盒、精細過濾棉。

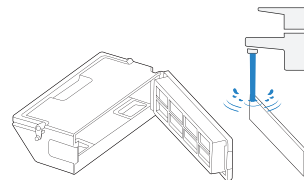

- 5 晾乾塵盒、精細過濾棉。

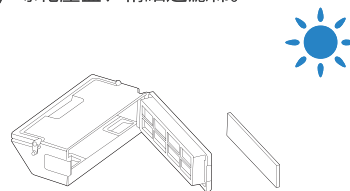

## 4. 部件保養 /4.4 主刷與邊刷

### 清理主刷

- 1 打開主刷蓋板

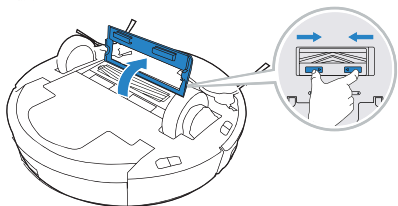

- 2 取出主刷

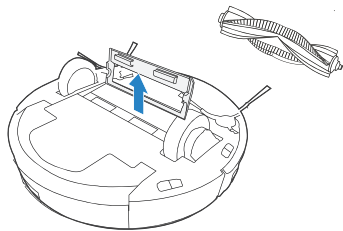

- 3 用清理小工具清理主刷

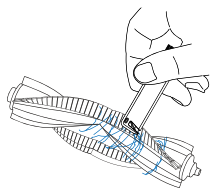

### 清理邊刷

- 1 取下邊刷

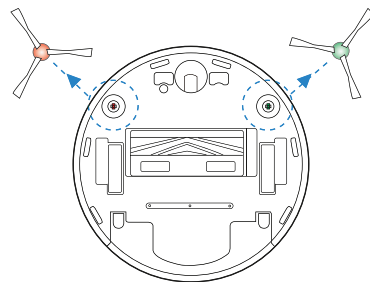

- 2 用清理小工具清理邊刷

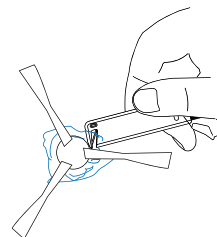

## 4. 部件保養 /4.5 AIVI 視覺識別傳感器鏡片、TrueMapping 激光掃描模塊、下視感應器與紅外緩衝防撞板

清理 AIVI 視覺識別傳感器鏡片

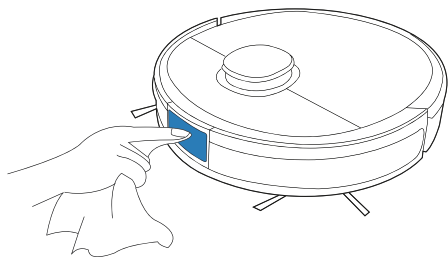

清理防摔落感應器

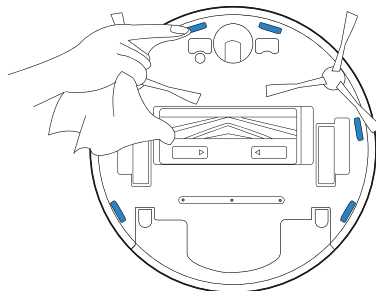

清理 TrueMapping 激光掃描模塊

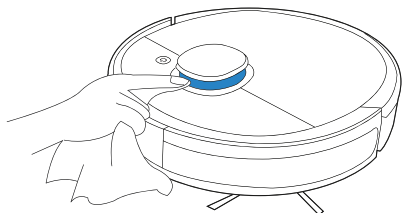

清理紅外線防撞緩衝板

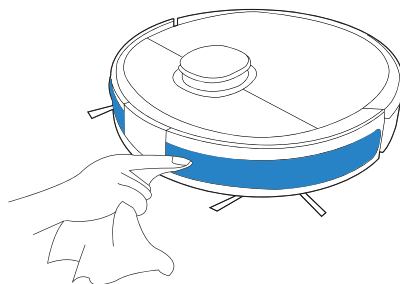

\* 請用乾淨的軟布擦拭 AIVI 視覺識別傳感器鏡片和 TrueMapping 激光掃描模塊，不要用洗劑、洗衣液、噴霧器。

\* 清理下視感應器和紅外緩衝防撞板時請使用乾布。請勿使用濕布，以防進水造成損壞。

## 4. 部件保養 /4.6 充電極片、驅動輪和方向輪

清理充電接收片

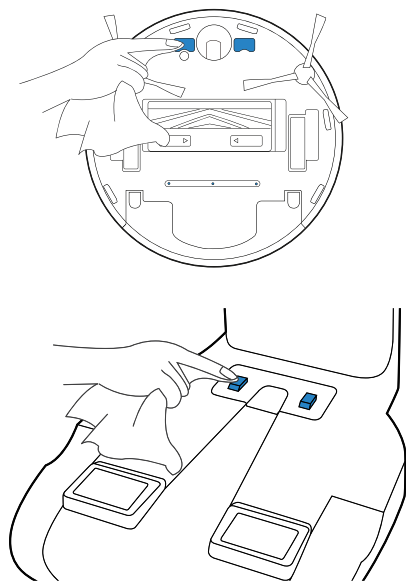

**小提醒：**充電接收片內部皆含精密的電子元件，請使用乾布清理，勿使用濕布以防進水造成損壞。

清理驅動輪

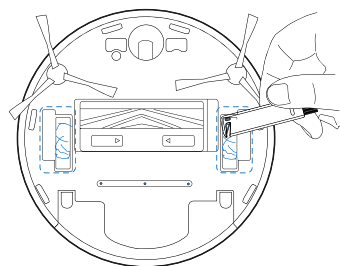

清理方向輪

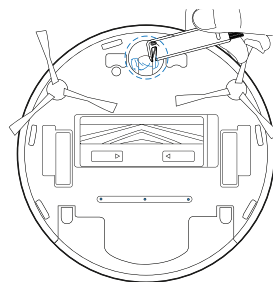



## 4. 部件保養 /4.7 塵袋

### 1 丟棄塵袋

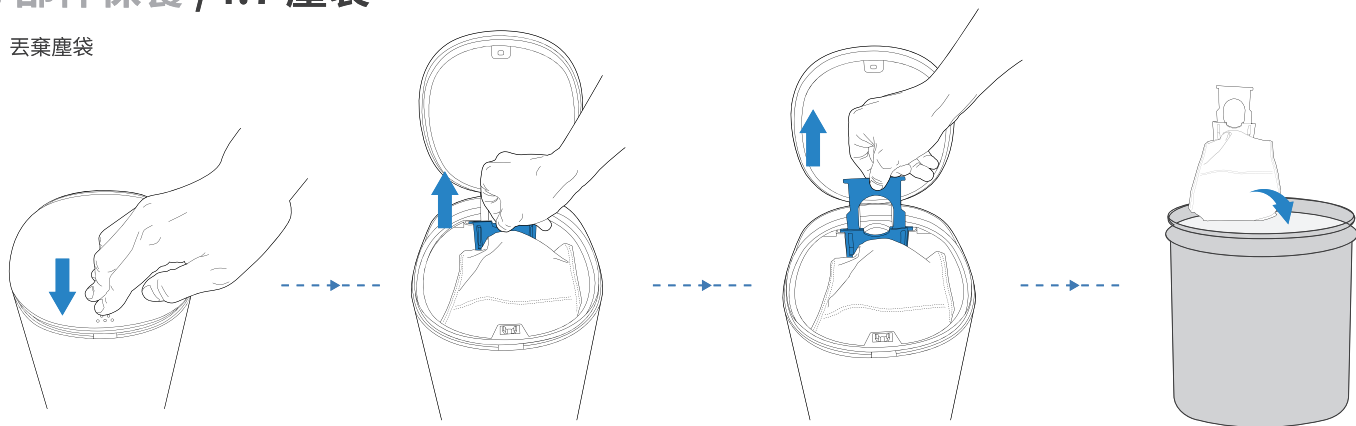

\* 取出時，塵袋提手會將塵袋密閉起來，有效防止灰塵漏出。

### 2 擦拭濾網

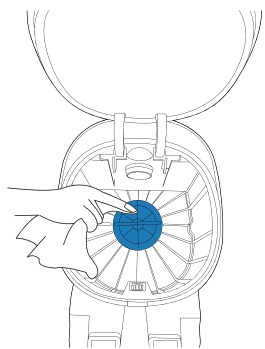

### 3 安裝新塵袋

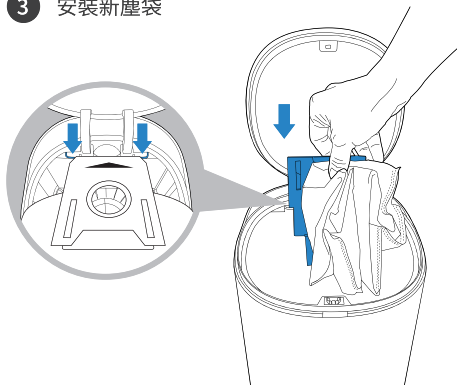

### 4 關上集塵座外蓋

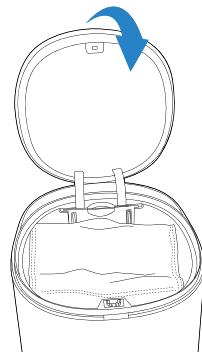

## 4. 部件保養 /4.8 風道

擰下風道蓋板螺絲

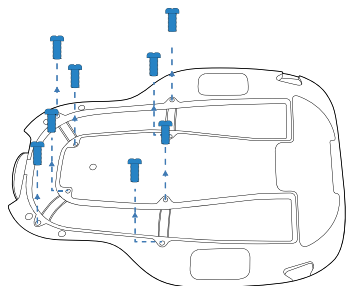

取下風道蓋板

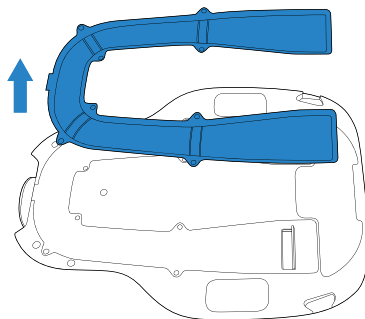

用清理小工具清掃風道

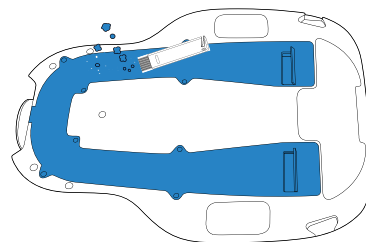

## 4. 部件保養 /4.9 關機存放

若長時間不使用產品，儲存前請先將其充滿電，再關閉電源開關，並堅持每 1.5 個月為其補充電，以防電池缺電。

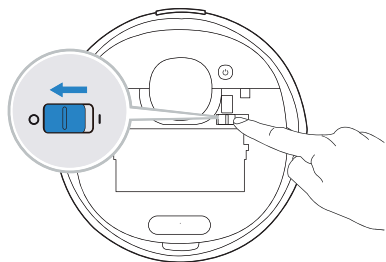

**!** 請注意，主機無法在電源關閉的情況下充電。

- \* 機器人工作結束後，建議不要關機，保持機器人在充電狀態，以便進行下一回合的工作。
- \* 電池過放或長期不使用，產品可能無法充電，請聯繫本公司售後進行維修，切勿自行拆卸。

## 5. 狀態指示燈

Auto-Empty 集塵座的狀態指示燈效對應不同的狀態和解決方案。如需更多支持，請參考本書常見問題章節。

燈效	狀態	解決方案
熄滅	集塵座待機中。	/
	地寶處於勿擾模式。	/
白燈常亮	地寶返回充電座，開始自動集塵。	/
	集塵座正在集塵。	/
	集塵座在集塵過程中發現吸力下降。	請清理集塵袋。
紅燈常亮	集塵座未安裝塵袋。	請安裝塵袋。
	集塵座嘗試集塵失敗。	無法自動集塵，請在 App 中查看解決方案。
	集塵桶麵蓋未蓋緊。	請蓋緊集塵座面蓋。

## 6. 常見問題 /6.1 常見問題

使用過程中如遇以下情況。可參照查詢，自行排解。

序號	故障情況	可能原因	解決方法
1	機器人無法連上 App。	路由器使用者名稱和密碼不正確。	設定路由器網路，確保輸入的路由器「使用者名稱」和「密碼」正確。
		機器人不在路由器的網路訊號覆蓋範圍內。	確保機器人在路由器的網路訊號覆蓋範圍內。
		機器人未處於待機狀態。	主機處於待配置狀態時，才能對其進行網路配置。主機通電，打開主機外蓋，短按一下  ，聽到主機提示音，即表示主機進入待配置狀態。
		沒有使用 2.4G 網路。	機器人暫不支援 5G 網路，連線時請使用 2.4G 網路進行網路設定。
		可能下載了錯誤的 App 應用。	請掃描本產品二維碼或去應用市場下載 ECOVACS HOME App。
2	地圖丟失。	搬動主機，可能有丟失地圖的風險。	有地圖保存的情況下，如果地圖丟失，搬回集塵座即可恢復。
3	無法在 App 上創建家居地圖。	DEEBOT 未從集塵座出發。	DEEBOT 須從集塵座出發開始清掃。
		清掃過程中搬動 DEEBOT，導致 DEEBOT 定位失敗。	清掃過程中，請盡可能避免搬動 DEEBOT。
		自動清掃任務未完成。	讓 DEEBOT 清掃完成後自動返回集塵座。
		首次創建地圖時使用 OZMO Pro 電動高頻擦地系統。	首次創建地圖時請使用默認水箱。成功創建家居地圖後即可體驗 OZMO Pro 電動高頻擦地系統。
4	水箱脫落。	安裝不確實。	安裝時請用力推至「咔」一聲，確保水箱安裝確實。
5	邊刷脫落。	安裝不確實。	安裝時需要聽到「咯」的一聲，確保邊刷安裝到位。

序號	故障情況	可能原因	解決方法
6	找不到集塵座信號，無法返回集塵座。	集塵座放置處不正確。	請依循操作手冊【 <b>機器人充電</b> 】內指示，正確擺放集塵座。
		集塵座斷電或被人為移動。	請檢查集塵座有無連接電源。請勿人為移動集塵座位置。
		主機暫停工作超過 90 分鐘。	建議暫停主機時間不要超過 90 分鐘，為保證主機順利運行，請讓主機自主完成清掃，盡可能避免暫停和搬動。
		機器人未從集塵座出發清掃。	建議讓機器人自集塵座出發清掃。
		回充路線被阻斷。例如，有集塵座的房間房門被關閉。	請保持回充路線通暢。
7	未清掃完畢，主機返回充電。	房間較大，主機需要中途返回充電。	建議開啓斷點續掃，具體操作方法可參考 App 指引。
		家居環境非常複雜的情況下，清掃效率會降低，可能無法清掃完。	整理家居環境。
8	機器人無法充電。	主機電源開關未打開。	機器人電源開關需為「I」狀態即可充電。
		主機與集塵座的充電極片未充分接觸。	確保機器人集塵座的充電接收片已確實連接，  鍵顯示為閃爍狀態。檢查機器人和集塵座的充電接收片有無污垢，細節參閱操作手冊【 <b>部件保養</b> 】。
		集塵座未接上電源。	確保集塵座已接上電源。
		長時間未使用，導致電池過度放電。	建議經常使用本產品，如果長時間未使用導致無法充電，請聯繫售後服務人員。
9	機器人工作的運行聲音過大。	邊刷、主刷被纏住；集塵盒、過濾材料發生堵塞等。	建議定期清理集保養邊刷、主刷、集塵盒、過濾材料等。
		主機進入強勁清掃模式。	更改為標準清掃模式。
		主機選用 OZMO Pro 電動高頻擦地系統進行擦地。	OZMO Pro 電動高頻擦地系統每分鐘擦地 480 次，音量可能稍大，屬於正常現象，請放心使用。

序號	故障情況	可能原因	解決方法
10	機器人運作困難。	機器人受到地板上散落電線、下垂窗簾布或地板流蘇纏繞或阻礙。	機器人會自主嘗試脫困，若無法自行脫困，建議手動協助。
		機器人可能被與主機高度相近的家具卡住。	建議墊高家具，或人為遮擋，或通過 App 引導設置虛擬牆。
		使用 OZMO Pro 電動高頻擦地系統時，主機越障能力可能減弱。	越過坡度較高的地方時，請協助主機排除問題。
11	<p>機器人工作時有路線不明、偏差、重複清掃及部分區域未清掃等狀況。（請放心，如為大面積區域暫時未掃，機器人會自行補掃；部份情況下，機器人會再次進入已清掃過的房間進行補掃。）</p>	地板上的電線、拖鞋等物品影響到 DEEBOT 正常工作。	請於機器人工作前，整理地板散落的電線、拖鞋等物品，減少地面雜物。如有漏掃狀況，機器人會自行補掃，無需人為干擾（如搬動機器人或阻擋機器人行進路線）。
		可能由於主機攀爬階梯、門檻、門條時，驅動輪在地面上打滑，從而影響到主機對整屋環境的判斷。	建議關好該區域的房門，單獨清掃該區域，清掃完成後會返回至起點，請您放心使用。
		在剛打蠟、拋光的地板或光滑的地磚上工作，會減少驅動輪和地面的摩擦力。	建議您等待地板打蠟自然風乾後再使用。
		因家庭環境不同，機器人會無法進入部分個別區域清掃。	建議整理居家環境，以確保機器人可以進入確實清掃。
		頂部 TrueMapping 激光掃描模塊污垢或被異物遮擋。	用乾淨的軟布擦拭 TrueMapping 激光掃描模塊或去除遮擋的異物。
12	視頻管家無法打開或沒有畫面。	Wi-Fi 連接失敗。	檢查主機 Wi-Fi 連接狀態，主機需要在 Wi-Fi 信號良好的區域才能正常開啓視頻管家。
		用戶授權沒有開啓。	請在隱私協議中勾選同意後再進行使用。
		由於家庭網路延遲大，可能暫時無法打開。	建議稍後再嘗試。
		AIVI 視覺識別傳感器被遮擋。	將遮擋物移除。

序號	故障情況	可能原因	解決方法
13	遠程操控操作延遲大。	主機連接的 Wi-Fi 信號不佳，導致視頻加載變慢。	建議在 Wi-Fi 信號良好的區域使用主機。
14	AIVI 視覺識別傳感器無法識別。	清掃區域光線不充足。	請在白天或打開房間燈清掃，AI 需要在光線充足的條件下才可正常識別。
		AIVI 視覺識別傳感器鏡片有汙漬或被遮擋。	用軟布擦拭鏡片，保持鏡片乾淨無遮擋。
15	主機返回集塵座後，未開始自動集塵。	集塵座外蓋未關閉。	請蓋緊集塵座外蓋。
		集塵座未安裝塵袋。	安裝塵袋，並關閉集塵座外蓋。
		手動搬動主機返回至集塵座，未觸發自動集塵。	為方便主機完成清掃後能夠順利返回充電集塵，建議讓主機自行返回集塵座，避免手動搬動主機。
		主機在視頻管家模式自動返回集塵座。	視頻管家模式主機不進行清掃，無需集塵。此為正常現象，請放心使用。
		當在 ECOVACS HOME App 中設置為勿擾模式時，主機在返回自動集塵座時不會開始集塵。	可在 ECOVACS HOME App 中取消勿擾模式，或手動啓動集塵。
		自動集塵效率降低。	按照說明書【 <a href="#">部件保養</a> 】的說明更換塵袋，並關閉集塵座外蓋。如 App 提示時，塵袋尚未裝滿，取出塵袋再次裝回即可。
		如以上的可能原因都已經排除，可能是集塵座元器件異常。	請聯繫客戶服務。



序號	故障情況	可能原因	解決方法
16	自動集塵不成功。	自動集塵效率降低。	按照說明書【 <a href="#">部件保養</a> 】提示更換塵袋，並關閉集塵座外蓋。如 App 提示時，塵袋尚未裝滿，取出塵袋再次裝回即可。
		集塵塵盒的集塵出口被異物卡住。	取出集塵塵盒，並清理集塵出口上的異物。
		集塵座風道堵塞。	按照說明書【 <a href="#">部件保養</a> 】章節，清理風道。
17	集塵座塵桶內污垢。	細微顆粒透過塵袋吸附在塵桶內側。	清理集塵座外蓋及塵桶內壁。
		塵袋破損。	檢查塵袋並更換。
18	主機運行中漏灰。	集塵塵盒的集塵出口被異物卡住。	取出集塵塵盒，並清理集塵出口上的異物。
19	集塵座底座污垢。	主機主刷掉落灰塵。	按照說明書【 <a href="#">部件保養</a> 】章節清理主機主刷。

## 6. 常見問題 /6.2 Wi-Fi 連接

設置 Wi-Fi 前，請確保 DEEBOT、手機和 Wi-Fi 網路符合以下要求。

### DEEBOT 和手機要求

- DEEBOT 已充滿電且已打開 DEEBOT 電源開關。
- Wi-Fi 狀態燈緩慢閃爍。
- 關閉手機的移動數據（完成設置後，可重新開啓）。

### Wi-Fi 網路要求

- 使用 2.4GHz 或 2.4/5 GHz 混合網路。
- 路由器支持 802.11b/g/n 和 IPv4 協議。
- 切勿使用 VPN（虛擬專用網路）或代理服務器。
- 切勿使用隱藏的網路。
- 使用 TKIP、PSK、AES/CCMP 加密的 WPA 和 WPA2。
- 不支持 WEP EAP（企業認證協議）。
- 在北美地區使用 Wi-Fi 信道 1-11，在北美以外地區使用 Wi-Fi 信道 1-13（請諮詢當地監管機構）。
- 如果使用網路擴展器/中繼器，則網路名稱 (SSID) 和密碼與主網路相同。

## 7. 產品參數

適用香港

產品型號	DBX11-31			
額定輸入	20 V $\equiv$ 1 A			
充電站型號	CH1918		CH1822*	
	額定輸入 (充電狀態)	220-240 V $\sim$ 50-60 Hz 0.3 A	輸入	100-240 V $\sim$ 50-60 Hz 0.5 A
	額定輸出	20 V $\equiv$ 1 A	輸出	20 V $\equiv$ 1 A
	功率 (集塵狀態)	1000 W		/
頻段	2400-2483.5 MHz			

\*CH1822 需另行購買。

**注意：**為持續進行產品改進，技術和設計規格可能會更改。

Wi-Fi 模塊的輸出功率小於 100mW。

## 適用台灣

產品型號	DBX11-31	
額定輸入	20 V $\equiv$ 1 A	
充電站型號	CH1918	
	額定輸入 (充電狀態)	110-120 V $\sim$ 50-60 Hz 0.5 A
	額定輸出	20 V $\equiv$ 1 A
	功率 (集塵狀態)	1000 W
工作頻率	2412-2462 MHz	

**注意：**為持續進行產品改進，技術和設計規格可能會更改。

Wi-Fi 模塊的輸出功率小於 100mW。







**Ecovacs Robotics Co., Ltd.**

No. 18 You Xiang Road, Wuzhong District, Suzhou City, Jiangsu Province, P.R.China

451-1913-9602 A00