



**DEEBOT  +
Instruction Manual**

Important Safety Instructions

IMPORTANT SAFETY INSTRUCTIONS

When using an electrical Appliance, basic precautions should always be followed, including the following:

READ ALL INSTRUCTIONS BEFORE USING THIS APPLIANCE

SAVE THESE INSTRUCTIONS

1. This Appliance can be used by children aged from 8 years and above and persons with reduced physical, sensory or mental capabilities or lack of experience and knowledge if they have been given supervision or instruction concerning use of the Appliance in a safe way and understand the hazards involved. Children shall not play with the Appliance. Cleaning and user maintenance shall not be made by children without supervision.
2. Clear the area to be cleaned. Remove power cords and small objects from the floor that could entangle the Appliance. Tuck rug fringe under the rug base, and lift items such as curtains and tablecloths off the floor.
3. If there is a drop off in the cleaning area due to a step or stairs, you should operate the

Appliance to ensure that it can detect the step without falling over the edge. It may become necessary to place a physical barrier at the edge to keep the unit from falling. Make sure the physical barrier is not a trip hazard.

4. Only use as described in this manual. Only use attachments recommended or sold by the manufacturer.
5. Please make sure your power supply source voltage matches the power voltage marked on the Auto-Empty Station.
6. For INDOOR household use ONLY. Do not use the Appliance in outdoor, commercial or industrial environments.
7. Use only the original rechargeable battery and Auto-Empty Station provided with the Appliance from the manufacturer. Non-rechargeable batteries are prohibited. For battery information, please refer to Specifications section.
8. Do not use without dust bin and/or filters in place.
9. Do not operate the Appliance in an area where there are lit candles or fragile objects.
10. Do not use in extremely hot or cold environments (below -5°C/23°F or above 40°C/104°F).
11. Keep hair, loose clothing, fingers, and all parts of body away from any openings and moving parts.

12. Do not operate the Appliance in a room where an infant or child is sleeping.
13. Do not use Appliance on wet surfaces or surfaces with standing water.
14. Do not allow the Appliance to pick up large objects like stones, large pieces of paper or any item that may clog the Appliance.
15. Do not use Appliance to pick up flammable or combustible materials such as gasoline, printer or copier toner, or use in areas where they may be present.
16. Do not use Appliance to pick up anything that is burning or smoking, such as cigarettes, matches, hot ashes, or anything that could cause a fire.
17. Do not put objects into the suction intake. Do not use if the suction intake is blocked. Keep the intake clear of dust, lint, hair, or anything that may reduce air flow.
18. Take care not to damage the power cord. Do not pull on or carry the Appliance or Auto-Empty Station by the power cord, use the power cord as a handle, close a door on the power cord, or pull power cord around sharp edges or corners. Do not run Appliance over the power cord. Keep power cord away from hot surfaces.
19. If the power cord is damaged, it must be replaced by the manufacturer or its service agent in order to avoid a hazard.
20. Do not use with a damaged power cord or receptacle. Do not use the Appliance or Auto-Empty Station if it is not working properly, has been dropped, damaged, left outdoors, or come in contact with water. It must be repaired by the manufacturer or its service agent in order to avoid a hazard.
21. Do not use with a damaged power cord or receptacle. Do not use the Appliance or Auto-Empty Station if it is not working properly, has been dropped, damaged, left outdoors, or come in contact with water. It must be repaired by the manufacturer or its service agent in order to avoid a hazard.
22. Turn OFF the power switch before cleaning or maintaining the Appliance.
23. The plug must be removed from the receptacle before cleaning or maintaining the Auto-Empty Station.
24. Remove the Appliance from the Auto-Empty Station, and turn OFF the power switch to the Appliance before removing the battery for disposal of the Appliance.
25. The battery must be removed and discarded according to local laws and regulations before disposal of the Appliance.
26. Please dispose of used batteries according to local laws and regulations.

27. Do not incinerate the Appliance even if it is severely damaged. The batteries can explode in a fire.
28. When not using the Auto-Empty Station for a long period of time, please unplug it.
29. The Appliance must be used in accordance with the directions in this Instruction Manual. ECOVACS ROBOTICS cannot be held liable or responsible for any damages or injuries caused by improper use.
30. The robot contains batteries that are only replaceable by skilled persons. To replace the robot's battery, please contact Customer Service.
31. If the robot will not be used for a long time, power OFF the robot for storage and unplug the Auto-Empty Station.
32. **WARNING:** For the purposes of recharging the battery, only use the detachable supply unit CH1918 provided with the Appliance, or CH1822 sold separately as an accessory.







To satisfy RF exposure requirements, a separation distance of 20 cm or more should be maintained between this device and persons during device operation.

To ensure compliance, operations at closer than this distance is not recommended. The antenna used for this transmitter must not be co-located in conjunction with any other antenna or transmitter.

To disable Wi-Fi module on DEEBOT, power the robot ON.

Place the robot on the Auto-Empty Station making sure the Charging Contacts on DEEBOT and the Auto-Empty Station Pins make a connection.

Press and hold the AUTO Mode Button on the robot for 20 seconds until DEEBOT emits 3 beeps. To enable Wi-Fi module on DEEBOT, power the robot OFF and then power ON. The Wi-Fi module is turned on when DEEBOT is restarted.

	Class II
	Short-circuit-proof safety isolating transformer
	Switch mode power supply
	For indoor use only
	Direct current
	Alternating current

For EU Countries

For EU Declaration of Conformity information, visit <https://www.ecovacs.com/global/compliance>



Correct Disposal of this Product

This marking indicates that this product should not be disposed of with other household waste throughout the EU. To prevent possible harm to the environment or human health from uncontrolled waste disposal, recycle it responsibly to promote the sustainable reuse of material resources. To recycle your used device, please use the return and collection systems or contact the retailer where the product was purchased. They can safely recycle this product.

Air Freshener Capsule (Wild Bluebell) :

Main Ingredients for Capsule: PET, Polypropylene.

Main Ingredients for Air Freshener: Ethylene/Vinyl Acetate copolymer, Fragrance.

See manufacturing date, expiration date, and lot number on pack.

*Each unit will last up to 60 days based on 1 hour of use per day on ambient temperature conditions.

CAUTION:

USE ONLY AS DIRECTED. KEEP OUT OF REACH OF CHILDREN AND PETS. EYE IRRITANT. Avoid contact with eyes, skin, and clothing. In case of contact with skin or eyes, wash immediately with plenty of water for 15 minutes. If eye irritation persists, consult a physician. Do not ingest. IF SWALLOWED, do not induce vomiting; call physician or poison control center immediately. DO NOT PLACE NEAR HEAT OR OPEN FLAME. The product is not to be used by persons with reduced physical, sensory or mental capabilities. Used on DEEBOT and for indoor air deodorization only. Do not disassemble the capsule. Wash hands after handling. Keep away from foodstuffs, beverages and feed. Keep in a dry and well-ventilated place. Dispose in accordance with local regulation.



WARNING:

May cause an allergic skin reaction.

Toxic to aquatic life with long lasting effects.

Harmful to aquatic life with long lasting effects.

Package Contents

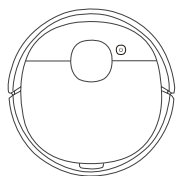

Robot

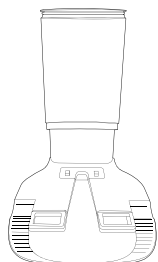

Auto-Empty Station

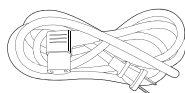

Power Cord



Dust Bag



Instruction Manual

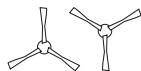

Side Brushes



OZMO Pro
Oscillating System



Disposable Mopping Pads



Air Freshener (Pre-installed)



Air Freshener Capsule

Product Diagram

Robot

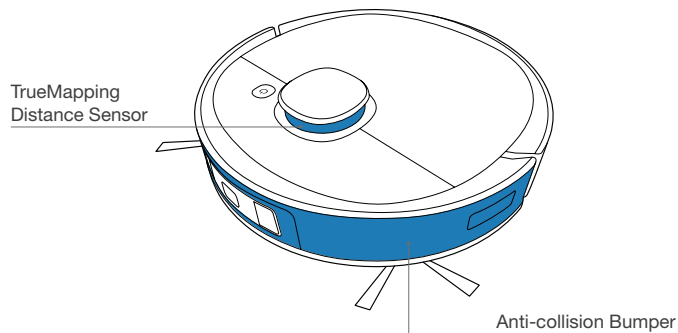
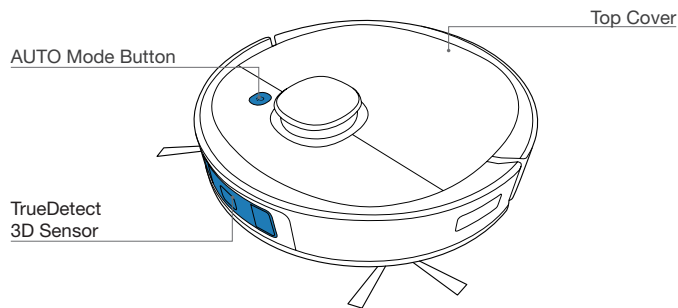

Note: Figures and illustrations are for reference only and may differ from actual product appearance. Product design and specifications are subject to changes without notice.

RESET Button

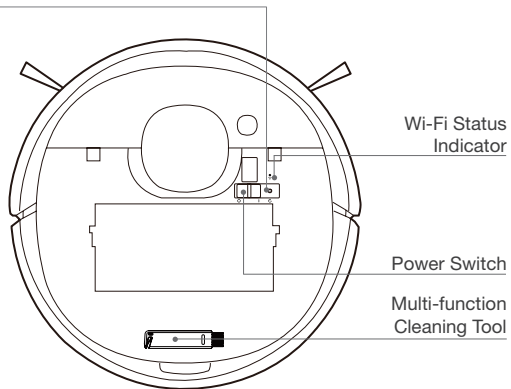

Bottom View

Charging Contacts

Carpet Detection Sensor

Main Brush

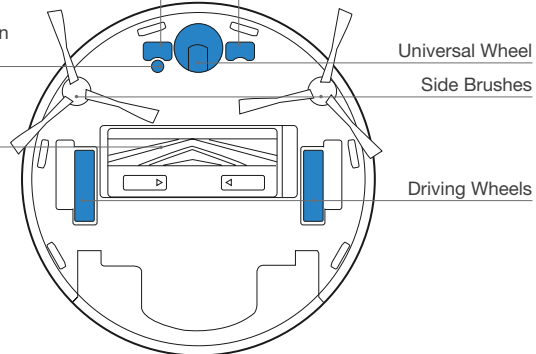

Anti-drop Sensors

Main Brush Release Button

Air Freshener (Pre-installed)

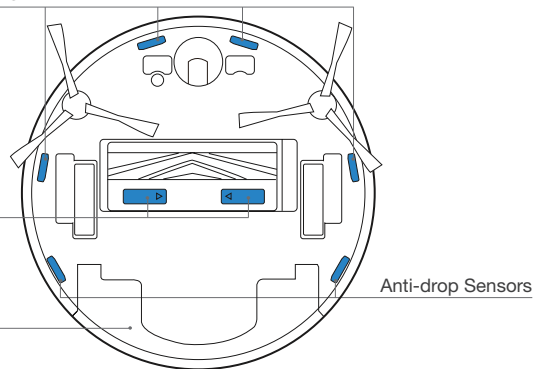

Auto-Empty Dust Bin

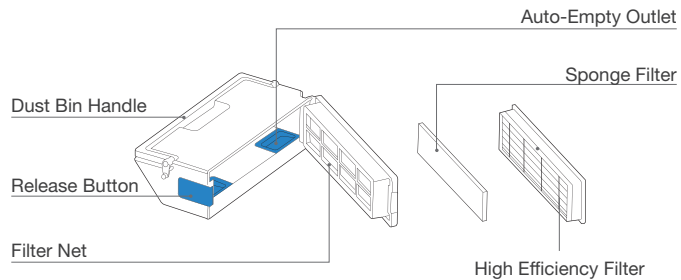

Auto-Empty Station

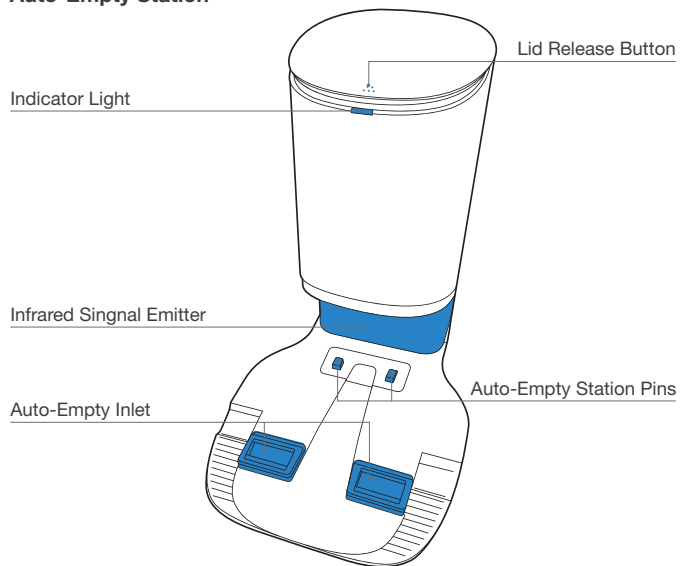

Auto-Empty Station (Back)

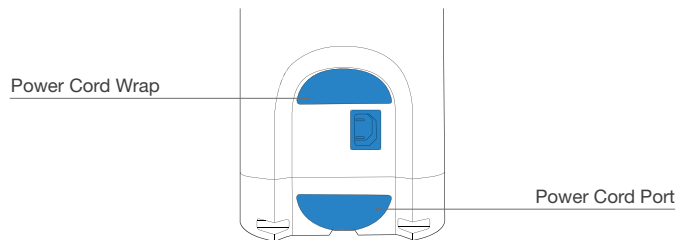

Auto-Empty Station (Top)

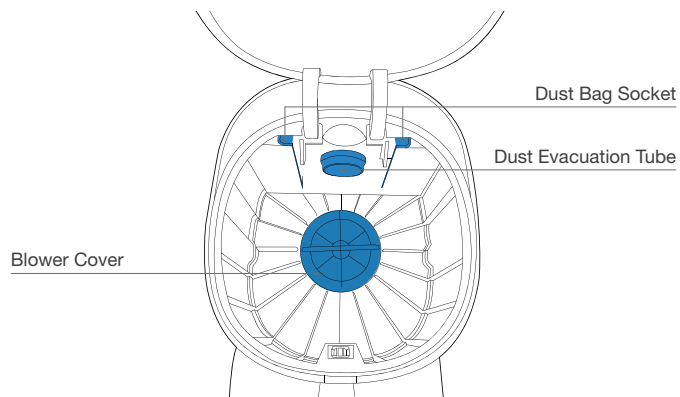

Auto-Empty Station (Bottom)

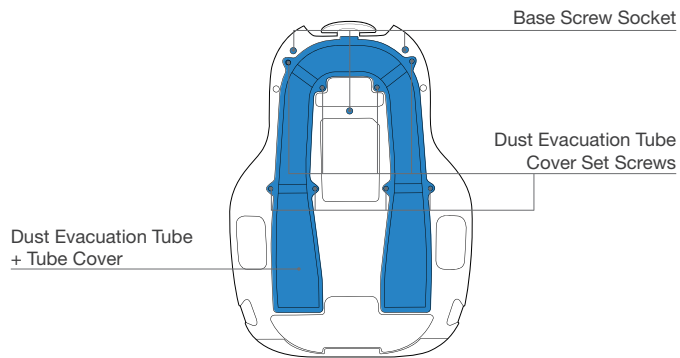

Power Cord

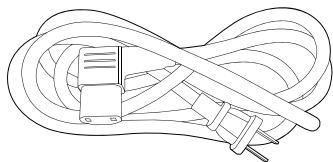

OZMO Pro Oscillating System

Reservoir



Water Inlet
Reservoir
Release Button

Disposable
Mopping Pad



Air Freshener (Pre-installed)

Air Freshener



Capsule Container

Notes Before Cleaning

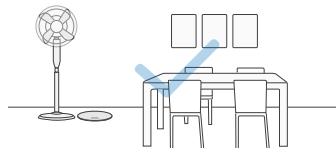

Tidy up the area to be cleaned by putting furniture, such as chairs, in their proper place.



During the first use, make sure each room door is open to help DEEBOT fully explore your house.

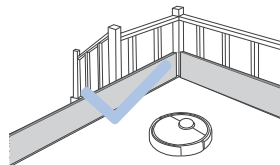

It may be necessary to place a physical barrier at the edge of a drop to stop the unit from falling over the edge.



Put away objects including cables, cloths and slippers, etc. on the floor to improve the cleaning efficiency.



Before using the product on a rug with tasseled edges, please fold the rug edges under.



Please do not stand in narrow spaces, such as hallways, and make sure not to block the Detection Sensor.

ECOVACS HOME App

To enjoy all available features, it is recommended to control your DEEBOT via the ECOVACS HOME app.

Before you start, make sure that:

- Your mobile phone is connected to a Wi-Fi network.
- The 2.4GHz band wireless signal is enabled on your router.
- The Wi-Fi indicator light on DEEBOT is slowly flashing.



Wi-Fi Indicator Light

	Slowly flashing	Disconnected to Wi-Fi or waiting for Wi-Fi connection
	Rapidly flashing	Connecting to Wi-Fi
	Solid	Connected to Wi-Fi

Wi-Fi Connection

Before Wi-Fi setup, make sure DEEBOT, mobile phone, and Wi-Fi network meet the following requirements.

DEEBOT and Mobile Phone Requirements

- DEEBOT is fully charged and the power switch of DEEBOT is turned on.
- Wi-Fi status light slowly flashes.
- Turn off mobile phone's cellular data (you can turn it back on after setup).

Wi-Fi Network Requirements

- You are using a 2.4GHz or 2.4/5 GHz mixed network.
- Your router supports 802.11b/g/n and IPv4 protocol.
- Do not use a VPN (Virtual Private Network) or Proxy Server.
- Do not use a hidden network.
- WPA and WPA2 using TKIP, PSK, AES/CCMP encryption.
- WEP EAP (Enterprise Authentication Protocol) is not supported.
- Use Wi-Fi channels 1-11 in North America and channels 1-13 outside North America (refer to local regulatory agency).
- If you are using a network extender/repeater, the network name (SSID) and password are the same as your primary network.

Operating DEEBOT

During the first cleaning:

1. Please make sure to install Air Freshener to create a home map in ECOVACS HOME App.
2. Please supervise DEEBOT and assist it should there be a problem.

1 Start

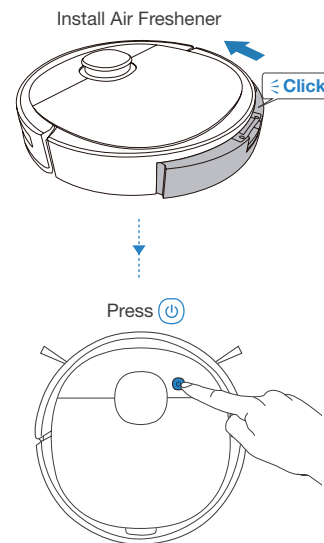

Note: DEEBOT is designed to recognize the edge or a stair based on the perception of dark colors via Anti-Drop Sensors. Thus, please be advised that DEEBOT may not run on certain dark or black-colored surfaces, since DEEBOT may perceive them as an edge or stairs and back away from these areas. Please be highly alerted that if you block or disable the Anti-Drop Sensors, DEEBOT may fall off the edge or the stairs.

2 Pause

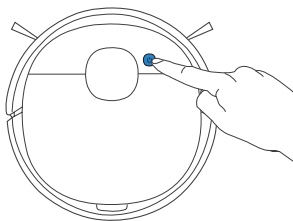

Note: The robot's Control Panel stops glowing after the robot is paused for a few minutes. Press the AUTO Mode Button on DEEBOT to wake up the robot.

3 Return to Charge

Pressing  for 3 seconds to send DEEBOT back to the Auto-Empty Station.

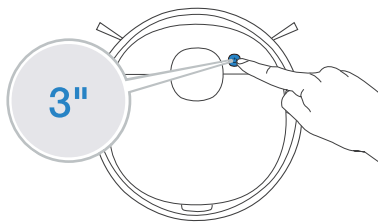

OZMO Pro Oscillating System

Note:

1. Install OZMO Pro Oscillating System for floor scrubbing.
2. With electric oscillating mopping up to 480 times per minute, OZMO Pro is applicable for areas of highly concentrated dirt or dust.
3. Before installing OZMO Pro, please make sure the contacts are thoroughly dry.
4. Please avoid using OZMO Pro on the carpet.

1 Add Water

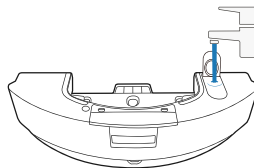

- * To prolong the service life of OZMO Pro, it is recommended to use purified water or softened water.
- * Do not soak OZMO Pro in water.

2 Attach Disposable Mopping Pad

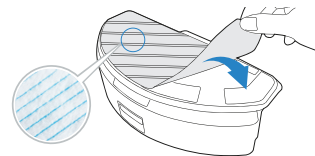

3 Dry Contacts Thoroughly

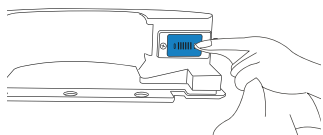

4 Install OZMO Pro

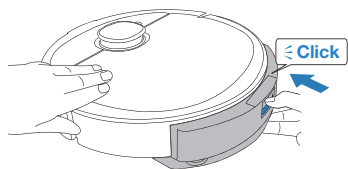

5 Start Cleaning

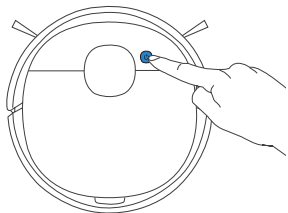

Air Freshener

1 Install Air Freshener Capsule

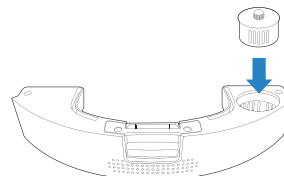

2 Dry Contacts Thoroughly

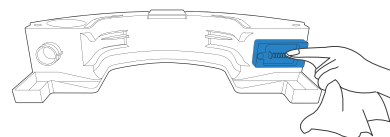

3 Install Air Freshener

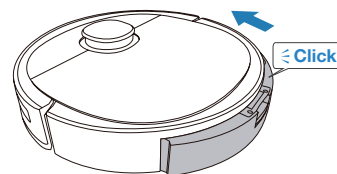

4 Enable Air Freshening via ECOVACS HOME App

Regular Maintenance

To keep DEEBOT running at peak performance, perform maintenance tasks and replace parts with the following frequencies:

Robot Part	Maintenance Frequency	Replacement Frequency
Air Freshener Capsule	/	Every 2 months
Disposable Mopping Pad	After each use	Replace after each use
Side Brush	Once every 2 weeks	Every 3-6 months
Main Brush	Once per week	Every 6-12 months
Sponge Filter/High Efficiency Filter	Once per week	Every 3-6 months
TrueDetect 3D Sensor Universal Wheel Anti-Drop Sensors Bumper Charging Contacts Auto-Empty Station Pins	Once per week	/

Before performing cleaning and maintenance tasks on DEEBOT, turn the robot OFF and unplug the Auto-Empty Station.

A multi-function Cleaning Tool is provided for easy maintenance. Handle with care, this cleaning tool has sharp edges.

Note: ECOVACS manufactures various replacement parts and fittings. Please contact Customer Service for more information on replacement parts.

Maintain OZMO Pro Oscillating System

1 Remove OZMO Pro

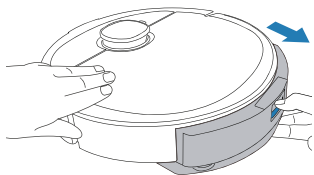

* After DEEBOT finishes mopping, please empty the reservoir.

2 Wipe OZMO Pro Clean

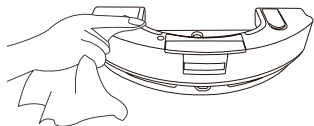

* Wipe OZMO Pro Oscillating System with a clean, dry cloth. Do not soak into water.

3 Disposable Mopping Pad

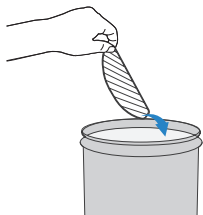

Maintain Auto-Empty Dust Bin and Filters

1

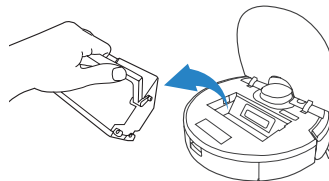

2

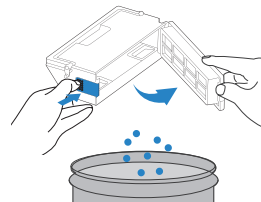

3

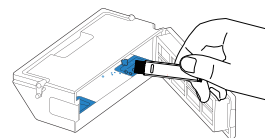

4

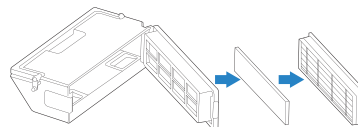

Maintain Main Brush and Side Brushes

Main Brush

5

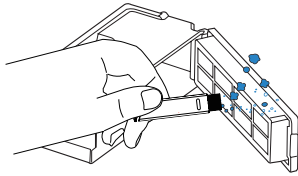

6

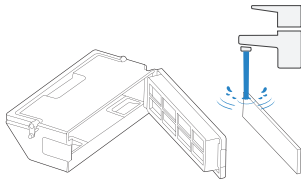

7

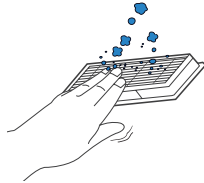

8

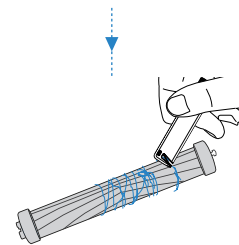
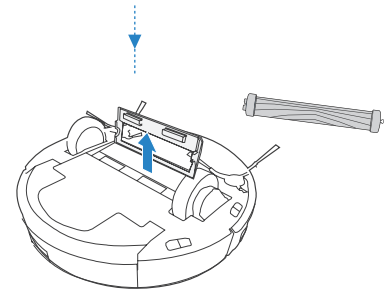
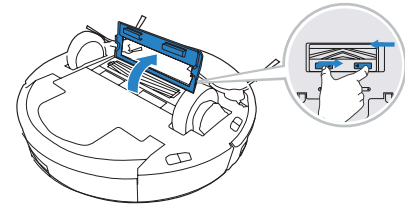
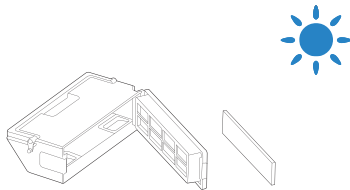

Side Brushes

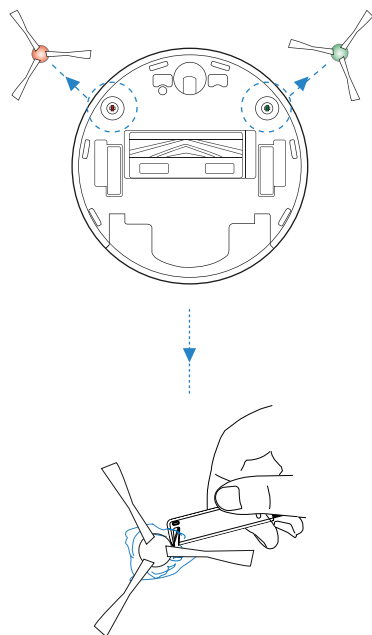

Maintain Auto-Empty Station

Note: Before performing cleaning and maintenance on Auto-Empty Station, unplug it first.

* For a proper maintenance, wipe with a clean dry cloth, and avoid using any detergent or cleaning spray.

Auto-Empty Station Pins

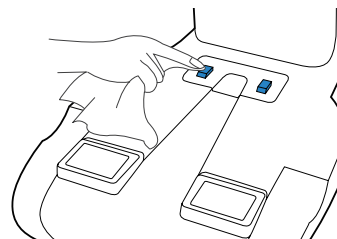

Infrared Signal Emitter

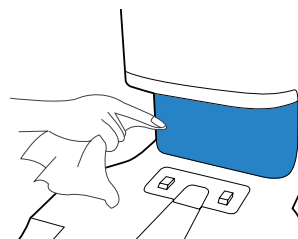

Dust Bag

1 Dispose the Dust Bag

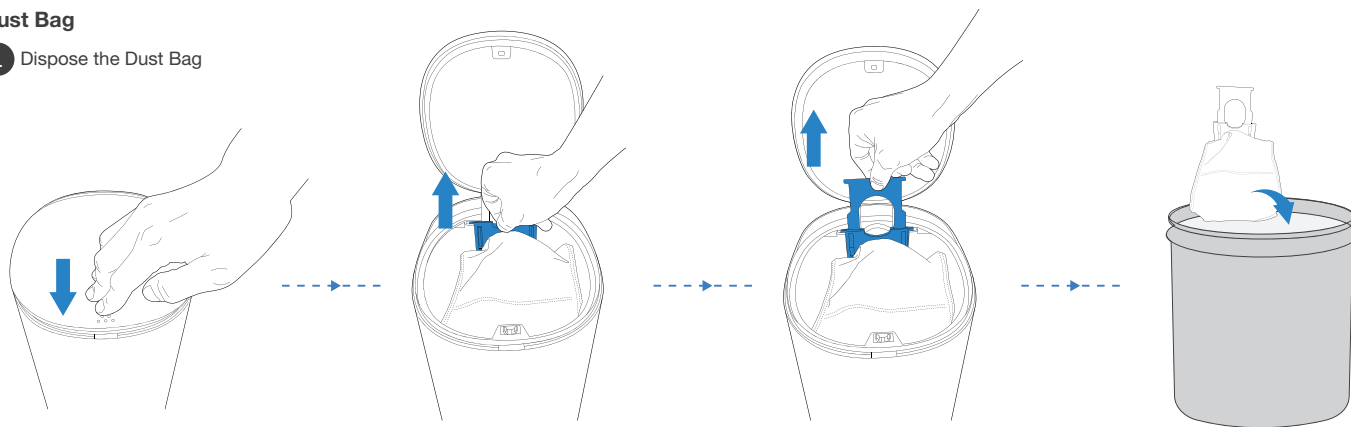

* The Dust Bag will be sealed by the handle so the dust will not leak.

2 Clean the Blower Cover

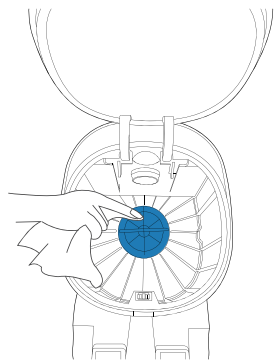

3 Install the Dust Bag

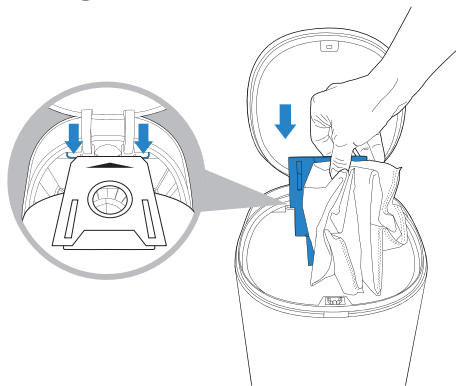

4 Close the Dust Container Lid

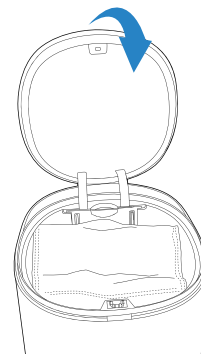

Dust Evacuation Tube

- 1 Unscrew the Dust Evacuation Tube Cover

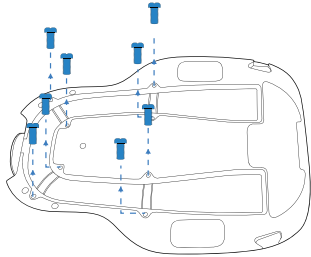

- 2 Uninstall the Dust Evacuation Tube Cover

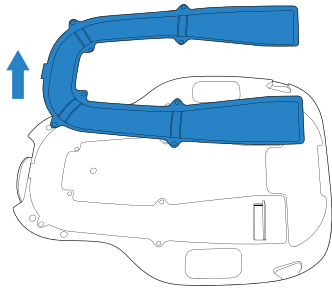

- 3 Clean the Dust Evacuation Tube

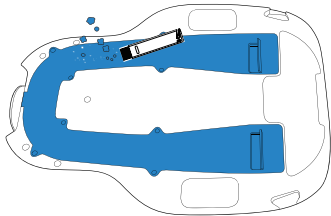

Maintain Other Components

Note: Before cleaning the robot's Charging Contacts and Auto-Empty Station Pins, turn the robot OFF and unplug the Auto-Empty Station. Wipe the components with a clean, dry cloth. Avoid using cleaning sprays or detergents.

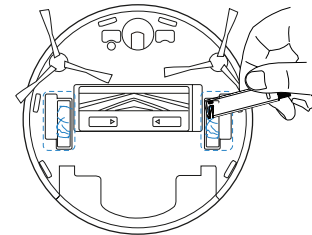
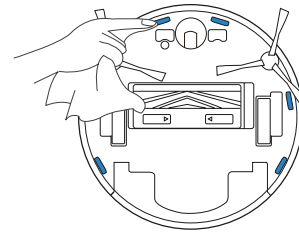
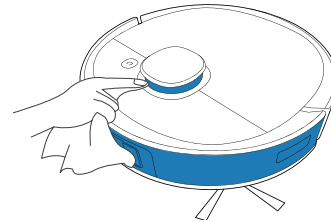

Indicator Light

DEEBOT

DEEBOT will tell you something is wrong with an indicator light and voice report. More detailed support is available through the ECOVACS HOME and online website.

Indicator Light	Scenario
AUTO Mode Button glows a solid WHITE.	The robot is cleaning.
	The robot is paused while cleaning.
AUTO Mode Button flashes WHITE.	The robot is charging.
	The robot is starting.
	The robot is relocating.
AUTO Mode Button glows a solid RED.	The robot has low battery.
AUTO Mode Button flashes RED.	The robot has a problem.

Auto-Empty Station

The light effect of the Status Indicator on Auto-Empty Station corresponds to different conditions and solutions. For more support, please refer to ECOVACS HOME App or the Troubleshooting Section of this manual.

Light Effect	Status	Solutions
Indicator light off	The Auto-Empty Station is in standby.	/
	DEEBOT is in Do Not Disturb Mode.	/
Glowing a solid WHITE	DEEBOT returns to the Auto-Empty Station and starts to Auto-Empty.	/
	DEEBOT is Auto-Emptying.	/
	The Auto-Empty Station's suction power decreased.	Please check the Dust Bag.
Glowing a solid RED	The Dust Bag is not installed.	Please install the Dust Bag.
	The Auto-Empty Station failed to Auto-Empty the dust.	Please check the solution in the App.
	The Dust Container Lid is not closed.	Please make sure the Dust Container Lid is firmly closed.

Troubleshooting

No.	Problem	Possible Causes	Solutions
1	DEEBOT is not charging.	DEEBOT is not switched ON.	Switch ON DEEBOT.
		DEEBOT has not connected to the Auto-Empty Station.	Be sure that the robot's Charging Contacts have connected to the Auto-Empty Station Pins.
		The Power Cord is not connected to the Auto-Empty Station.	Make sure the Power Cord is firmly connected to the Auto-Empty Station.
		The Auto-Empty Station is not connected to the power supply.	Make sure the Auto-Empty Station is connected to the power supply.
		The battery is completely discharged.	Please contact Customer Care for help.
2	DEEBOT cannot return to the Auto-Empty Station.	The Auto-Empty Station is not correctly connected.	Make sure the Auto-Empty Station is correctly connected.
		The Auto-Empty Station is manually moved during the cleaning.	It is suggested not to move the Auto-Empty Station during the cleaning.
		DEEBOT is paused for more than 90 minutes.	It is suggested not to pause DEEBOT for more than 90 minutes.
		DEEBOT did not start cleaning from the Auto-Empty Station.	Make sure DEEBOT starts cleaning from the Auto-Empty Station.
3	DEEBOT gets stuck while working and stops.	DEEBOT is tangled with something on the floor (electrical wires, curtains, carpet fringing, etc.).	DEEBOT will try various ways to free itself. If it is unsuccessful, manually remove the obstacles and restart.
		DEEBOT might be stuck under furniture with an entrance of similar height.	Please set a physical barrier, or set a Virtual Boundary in the ECOVACS HOME App.

No.	Malfunction	Possible Causes	Solutions
4	DEEBOT returns to the Auto-Empty Station before it has finished cleaning.	Working time varies according to floor surface, room complexity and the Cleaning Mode selected. When the battery gets low, DEEBOT automatically switches to Recharge Mode and returns to the Auto-Empty Station to recharge itself.	Turn on Continuous Cleaning function in ECOVACS HOME App. DEEBOT will automatically resume the uncompleted cleaning cycle when Continuous Cleaning is enabled.
		DEEBOT is unable to reach certain areas blocked by furniture or barriers.	Tidy up the area to be cleaned by putting furniture and small objects in their proper place.
		The Auto-Empty Station is too distant from the center of the house.	Please place the Auto-Empty Station against the wall of a central room of the house.
5	DEEBOT does not clean automatically at the scheduled time.	Time Scheduling function is cancelled.	Program DEEBOT to clean at specific times using the ECOVACS HOME App.
		DEEBOT is switched OFF.	Switch ON DEEBOT.
		The robot's battery is low.	Keep DEEBOT switched ON and connected to the Auto-Empty Station to make sure it has a full battery to work at any time.
6	DEEBOT misses cleaning spots to be cleaned, or repeats cleaning the area cleaned.	The cleaning cycle is interfered by small objects or barriers on the floor.	Remove power cords and small objects from the floor to ensure cleaning efficiency. DEEBOT will automatically clean the area missed, please avoid moving DEEBOT manually or block the path during the cleaning cycle.
		DEEBOT is working on slippery polished floors.	Make sure the floor wax is dried before DEEBOT starts cleaning.
		DEEBOT is unable to reach certain areas blocked by furniture or barriers.	Tidy up the area to be cleaned by putting furniture and small objects in their proper place.
		The TrueMapping Distance Sensor is blocked.	Remove the objects that are blocking the TrueMapping Distance Sensor.

No.	Malfunction	Possible Causes	Solutions
7	DEEBOT is not able to connect to the home Wi-Fi network.	Incorrect home Wi-Fi username or password entered.	Enter the correct home Wi-Fi username and password.
		Incorrect App installed.	Please download and install ECOVACS HOME App.
		DEEBOT is not within range of your home Wi-Fi signal.	Make sure DEEBOT is within range of your home Wi-Fi signal.
		Network setup started before DEEBOT was ready.	Turn ON Power Switch. Press the RESET Button. DEEBOT is ready for network setup when its Wi-Fi Indicator light flashes slowly.
		DEEBOT does not support 5 GHz Wi-Fi.	Make sure the robot has been connected with 2.4 GHz Wi-Fi network.
		Your smartphone's operating system needs to be updated.	Update your smartphone's operating system.
8	DEEBOT does not clean the whole area.	The cleaning area is not tidy.	Remove small objects from the floor and tidy up the cleaning area before DEEBOT starts cleaning.
9	DEEBOT reservoir drops out of place during use.	The reservoir is not correctly installed.	Make sure DEEBOT reservoir clicks into place when installing.
10	DEEBOT Side Brushes drop out of place during use.	The Side Brushes are not correctly installed.	Make sure the Side Brushes click into place when installing.

No.	Malfunction	Possible Causes	Solutions
11	DEEBOT does not start auto-emptying after returning to the Auto-Empty Station.	The Dust Container Lid is not closed.	Close the Dust Container Lid.
		The Dust Bag is not installed to the Auto-Empty Station.	Install the Dust Bag and close the Dust Container Lid.
		Manually move DEEBOT to the Auto-Empty Station will not trigger Auto-Emptying.	In order to make sure DEEBOT starts auto-emptying successfully, avoid picking up and moving the Auto-Empty Station during the cleaning.
		DEEBOT returns to the Auto-Emptying Station running Video Manager in the App.	This is normal.
		Do Not Disturb mode is enabled in ECOVACS HOME App.	This is normal. Disable Do Not Disturb mode in the App, or start auto-emptying manually.
		The Dust Bag is full.	Replace the Dust Bag and close the Dust Container Lid.
		If the possible causes are excluded, it might be a component malfunction.	Please contact customer service.
12	DEEBOT fails to auto-empty the Dust Bin.	The Auto-Empty Dust Bin is not installed.	Please install the Auto-Empty Dust Bin with two Auto-Empty Outlets on the bottom.
		The Dust Bag is full.	Replace the Dust Bag and close the Dust Container Lid.
		The Auto-Empty Outlets on the Auto-Empty Dust Bin is stuck by debris.	Uninstall the Auto-Empty Dust Bin and clean the debris on the Auto-Empty Outlets.
		Dust Evacuation Tube is blocked.	Clean the Dust Evacuation Tube.

No.	Malfunction	Possible Causes	Solutions
13	There is debris in the Dust Container.	Fine particles are absorbed inside the Dust Container through the Dust Bag.	Clean the Dust Container Lid and inner wall.
		The Dust Bag is damaged.	Check the Dust Bag and replace it.
14	DEEBOT leaks dust or debris while cleaning.	The Auto-Empty Outlets are stuck by debris.	Uninstall the Auto-Empty Dust Bin and clear the debris.
15	The Base is dirty.	Main Brush has debris on it and requires cleaning.	Clean the Main Brush.
16	There is no fragrance when using Air Freshener.	Fan malfunction.	Wipe the contacts and make sure Air Freshener is in contact.
		The Air Freshener Capsule is not installed.	Please install the Air Freshener Capsule.
		The Air Freshener Capsule reached its service life.	Please replace the Air Freshener Capsule. For more information for replacements, please visit https://www.ecovacs.com/global .
17	Air Freshener makes an abnormal noise.	Objects have fallen into the Air Freshener.	Please contact Customer Service for assistance.

Technical Specifications

Model	DLX13					
Rated Input	20V \equiv 1A					
Auto-Empty Station Model	CH1918			CH1822 (Sold Separately)		
Rated Input (Charging)	For European Union Only	220-240V \sim 50-60Hz 0.3A		Rated Input	100-240V \sim 50-60Hz 0.5A	
	For Russia Only	220V \sim 50-60Hz 0.3A				
	Rated Output		20V \equiv 1A		Rated Output	20V \equiv 1A
	Power (Auto-Emptying)		1000W		/	
Frequency bands	2400-2483.5MHz					
Off Mode Power	Less than 0.50W					
Networked Standby Power	Less than 2.00W					

Output power of the Wi-Fi module is less than 100mW.

Note: Technical and design specifications may be changed for continuous product improvement.

Ecovacs Robotics Co., Ltd.

No.518 Songwei Road, Wusongjiang Industry Park, Guoxiang Street,
Wuzhong District, Suzhou, Jiangsu, China.