



**WINBOT  PRO**  
**Instruction Manual/說明書**

## Important Safety Instructions

When using an electrical appliance, basic precautions should always be followed, including the following:

### **READ ALL INSTRUCTIONS BEFORE USING THIS APPLIANCE.**

### **SAVE THESE INSTRUCTIONS**

1. This appliance can be used by persons with reduced physical, sensory or mental capabilities or lack of experience and knowledge if they have been given supervision or instruction concerning use of the appliance in a safe way and understand the hazards involved. Children shall not play with the appliance. The appliance is not to be used if it has been dropped, if there are visible signs of damage or if it is leaking. Keep the appliance out of reach of children when it is energized.
2. Do not use and charge the Appliance in extremely hot or cold environments (below 0°C/32°F or above 40°C/104°F, above 85% humidity), or it may affect battery life span.
3. The Appliance can be used to clean exterior windows if it is properly tethered to a safe position with the Carabiner, winds are calm, and it is not raining or snowing.
4. Before use, please use the Carabiner to lock the safety tether to a strong indoor railing, and make sure WINBOT is securely attached to it.
5. Do not leave the Appliance unattended when using it. To prevent bodily injury or property damage caused by accidental falling of the Appliance, please make sure there are no people, animals, or valuable, fragile objects under the working area of WINBOT.
6. Do not use the Appliance in whole gale storms and force-10 winds, or in areas where the altitude exceeds 2000 meters (6562 feet).
7. Please ensure the Appliance is plugged in while it is cleaning. The Appliance has a Safety Battery that charges during use. The Safety Battery powers the Appliance if it becomes unplugged or the electricity fails.
8. Do not leave the Appliance unattended when it is plugged in.
9. For household use ONLY (including exterior window). Do not use the Appliance in commercial or industrial environments.
10. Do not use on broken or uneven glass, such as glass with static cling stickers, advertising posters, or raised patterns, so as to prevent glass breaking or Appliance's falling. Do not







use on surfaces with gaps, such as a piece of glass with gaps or holes, or two pieces of adjacent, frameless glass with a gap between them, so as to prevent the Appliance from falling due to poor attachment.

11. Only use accessories recommended or supplied by the manufacturer. Only use the Power Adapter supplied by the manufacturer.
12. Please make sure your power supply voltage matches the power voltage marked on the Power Adapter.
13. Do not use the Appliance on a framed glass with a frame smaller than 5 mm (0.2 in).
14. Do not use on glass less than 3 mm (0.12 in) thick or mirrors less than 4 mm (0.16 in) thick.
15. Do not use on glass or mirrors with a handle height of 70~105 mm (2.76~ 4.13 in).
16. Do not use the Appliance on greasy windows.
17. When used in high humidity environment, the cleaning performance will be affected.
18. Store the Appliance away from heat and flammable materials.
19. In rainy weather, do not use the Appliance on the exterior window to avoid the risk of Appliance's damage or falling.
20. Do not use the Appliance if it does not firmly attach to the glass or has visible signs of damage.
21. To reduce the risk of electrical shock, do not put the Appliance in water or other liquid. Do not place or store Appliance where it can fall or be pulled into a tub or sink.
22. Do not touch power plug with wet hands.
23. When charging the Appliance, do not place it on other electrical appliances and keep it away from fire and liquid.
24. Take care not to damage the power cord. Do not pull on or carry the Appliance by the power cord, use the power cord as a handle, close a window on the power cord, or put heavy weights on the power cord. Keep power cord away from hot surfaces.
25. Do not use with a damaged power cord or receptacle. Do not use the Appliance if it is not working properly, has been dropped, damaged, or come in contact with water. It must be repaired by the manufacturer or its service agent in order to avoid a hazard.
26. If the supply cord is damaged, it must be replaced by the manufacturer or its service agent in order to avoid a hazard.
27. The plug must be removed from the receptacle before cleaning or maintaining the Appliance. Do not unplug the Power Adapter by pulling on the power cord.

28. The Safety Battery must be replaced by the manufacturer or its service agent in order to avoid a hazard.
29. The Safety Battery must be removed and discarded according to local laws and regulations before disposal of the Appliance.
30. The Appliance must be disconnected from the receptacle before removing the battery for disposal of the Appliance.
31. Please dispose of used batteries according to local laws and regulations.
32. Do not incinerate the Appliance even if it is severely damaged. The battery can explode in a fire.
33. The Appliance must be used in accordance with the directions in this Instruction Manual. The company cannot be held liable or responsible for any damages or injuries caused by improper use.
34. **WARNING:** For the purposes of recharging the battery, only use the detachable supply unit BLJ96W240400P-B provided with this Appliance.
35. The robot contains batteries that are only replaceable by skilled persons.
36. The plug and the Power Adapter must be used indoor.

To satisfy RF exposure requirements, a separation distance of 20 cm or more should be maintained between this device and persons during device operation.

To ensure compliance, operations at closer than this distance is not recommended. The antenna used for this transmitter must not be co-located in conjunction with any other antenna or transmitter.

	<b>Class II</b>
	<b>Short-circuit-proof safety isolating transformer</b>
	<b>Switch mode power supply</b>
	<b>For indoor use only</b>
	<b>Direct current</b>
	<b>Alternating current</b>

## For EU Countries

For EU Declaration of Conformity information, visit <https://www.ecovacs.com/global/compliance>



## Correct Disposal of this Product

This marking indicates that this product should not be disposed of with other household waste throughout the EU. To prevent possible harm to the environment or human health from uncontrolled waste disposal, recycle it responsibly to promote the sustainable reuse of material resources. To recycle your used device, please use the return and collection systems or contact the retailer where the product was purchased. They can safely recycle this product.

# Package Contents

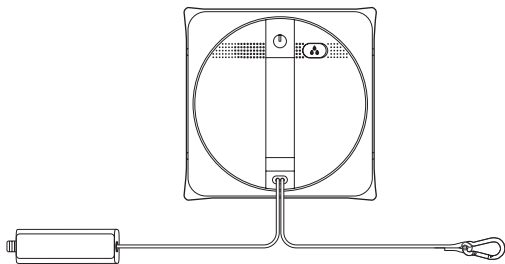

WINBOT+ Safety Tether and Carabiner  
+ Safety Battery

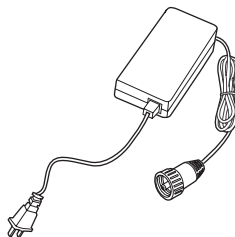

Power Adapter



Instruction Manual



ECOVACS WINBOT Cleaning Solution

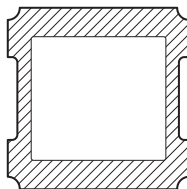

Mopping Pad

**Note:** Figures and illustrations are for reference only and may differ from actual product appearance. Product design and specifications are subject to change without notice.

# Product Diagram

## WINBOT

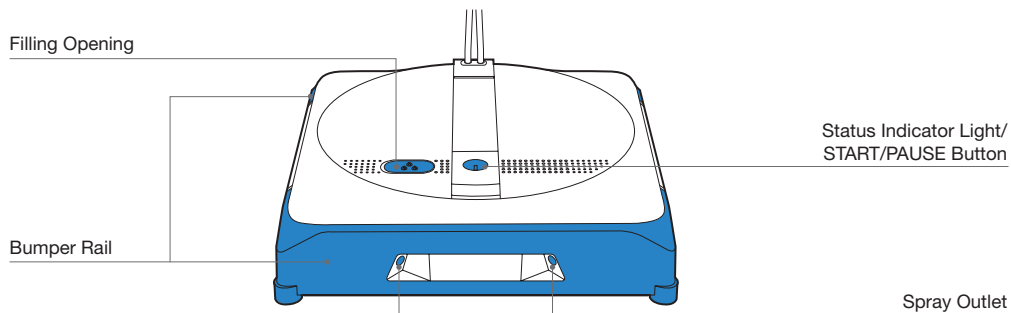

## Bottom View

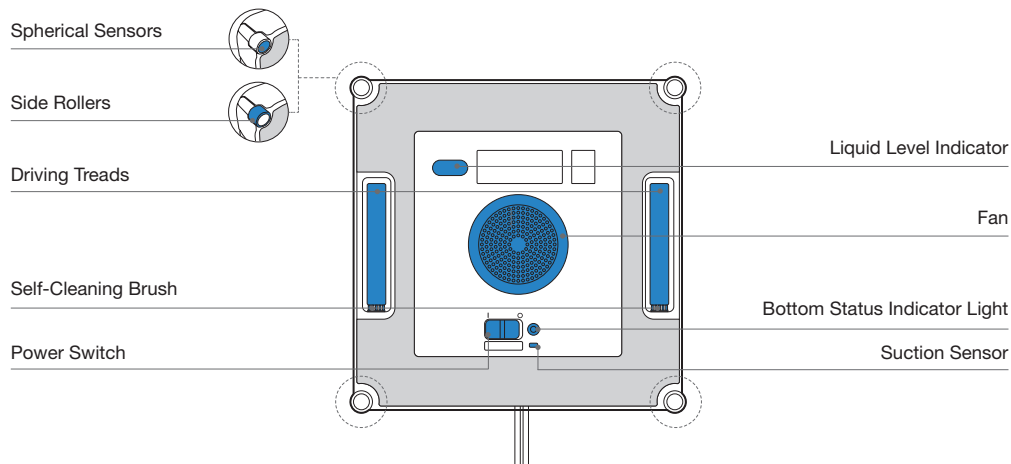

## Notes Before Cleaning

Make sure Safety Tether and Carabiner have been connected with WINBOT before using. (Connected by default. Do not disconnect before cleaning.)

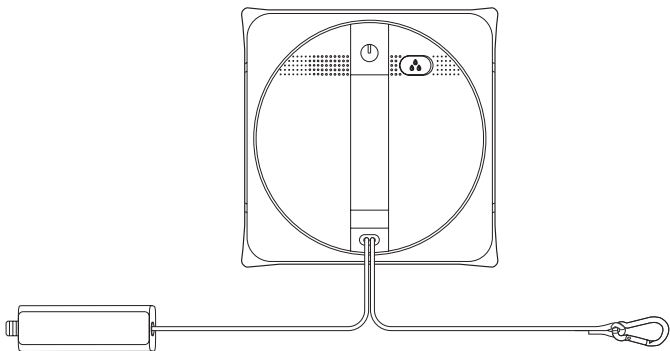

**Note:** Do not use WINBOT on a framed window with a frame narrower than 5 mm (0.2 in).

## Network Setup

To enjoy all available features, it is recommended to control your WINBOT via the ECOVACS HOME App.

### a. Three Cleaning Mode

Fast Cleaning Mode: Ensure efficient window cleaning

Deep Cleaning Mode: Realize all-round cleaning

Spot Cleaning Mode: Say goodbye to stubborn stains

### b. Manual Remote Control, Return to Corner:

Switch between interior and exterior window.

Manual remote control, to clean stubborn stains.

Return to Corner, to let WINBOT return to the specified corner immediately.

### c. Auto Water Spray and Manual Water Spray

Auto Water Spray defaulted leaves your windows clean.

WINBOT also supports Manual Water Spray.

### d. Smart Reminder of Consumables Replacement

Precise timing reminder, to get a better cleaning experience.





# Quick Start

## 1 Connect WINBOT Power Cord, Power Adapter and Plug

Please ensure the battery is fully charged before using. Charging time will be approx. 2 hours.

\*Do not cut the power off when WINBOT is running, otherwise it may lead to the risk of falling.

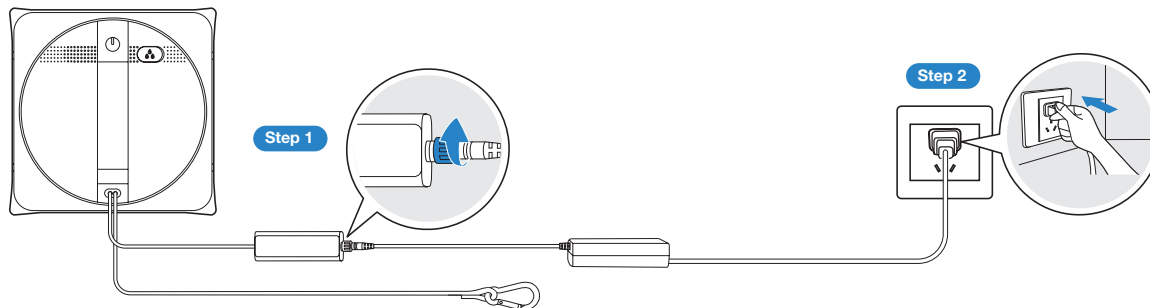

Connect correctly in the order shown above. Improper connection may cause charging abnormalities or damage to the battery.

## 2 Preparation before Use

### Fill up the Reservoir

It is recommended to use with ECOVACS WINBOT Cleaning Solution. The maximum volume of the Reservoir is about 60 ml, and it can spray for about 60 minutes when the Reservoir is full.

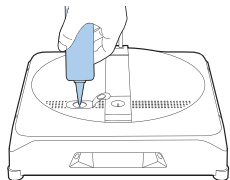

Maximum 60ml

**Note:** Do not add purified water and filtered water.

Do not add too much cleaning solution to overflow the Reservoir.

Using other cleaners could have an adverse effect on cleaning performance.

If the cleaning solution is used up, you can temporarily use tap water instead. Using the ECOVACS WINBOT Cleaning Solution can have a better cleaning performance.

## Install Mopping Pad

### ① Wet the Mopping Pad

Before using, wet the Mopping Pad manually.



### ② Twist the Mopping Pad

Twist the Mopping Pad to wring water out. To ensure cleaning performance, wring it out as much as you can.

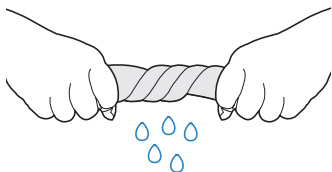

### ③ Stick the Mopping Pad

Stick the Mopping Pad onto the Velcro at the bottom of WINBOT, and press it with your hands to help the Mopping Pad stick firmly.

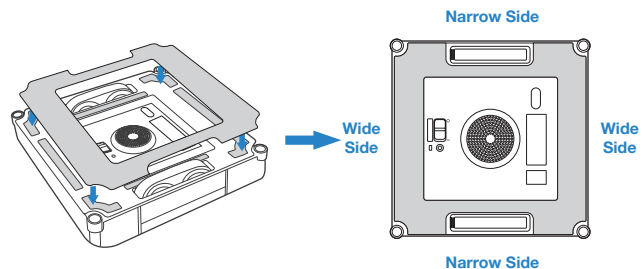

## Tie the Safety Tether

Properly tie the safety tether to a stable object that cannot be easily moved (e.g. table leg, chair leg, bed leg, sofa leg, curtain rod, stair handrail, etc.), and lock the carabiner as shown below.

Hang the rope and wrap it around the support.

Open the carabiner, then attach it to the rope on the other side.

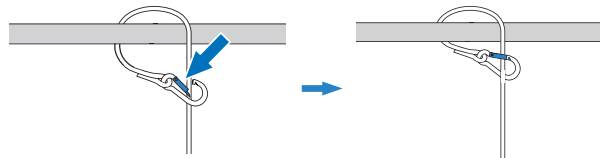

**Note:** To ensure safety, please make sure to secure the carabiner before use. It is recommended to fasten the Safety Tether with the Carabiner on a firm and safe metal railing.

### 3 Start

- ① Turn the Power Switch to "I".
- ② Attach to the Window.

**Method 1:** Shortly press  on WINBOT, then attach it to the glass.

**Method 2:** Evenly press WINBOT onto the glass for 3 seconds and more to make it firmly attached until you hear a voice prompt.

WINBOT will start cleaning after it has attached to the window successfully.

- \* Do not stick the WINBOT too close to the edge when cleaning the frameless glass. It is recommended to be more than 10 cm (3.94 in) away from the edge.
- \* WINBOT can only clean flat surfaces. Please make sure that the glass thickness is not less than 3 mm (0.12 in).
- \* Do not put the fan close to hair and other small objects after power on, so as not to block the fan.

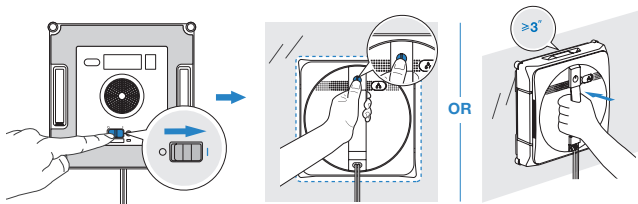

### 4 Maintenance during Cleaning

For heavily stained glass, please wash or replace the Mopping Pad several times and clean the four Spherical Sensors in time.

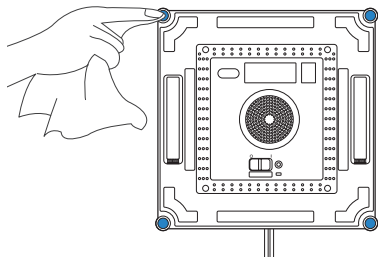

### 5 Finish

#### Pause

During cleaning, press  on WINBOT or pause it via App.

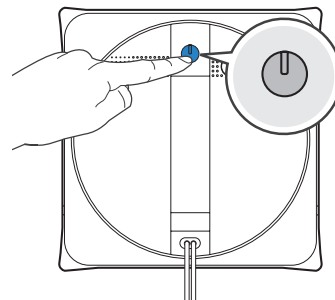

#### Remove WINBOT

When cleaning is complete, WINBOT will return to the starting position and beep. Press and hold  for 5 seconds and more, and remove it after the fan stops working.

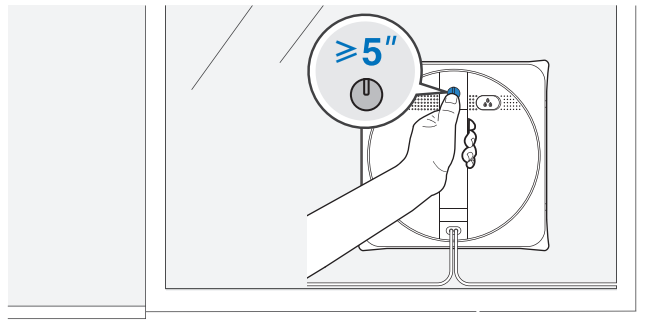

### Power Off

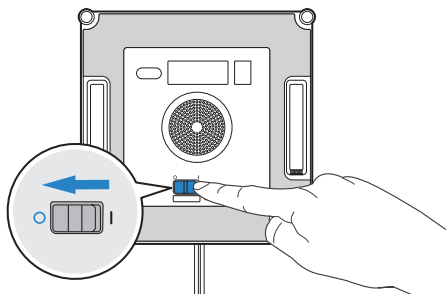

### Unplug WINBOT

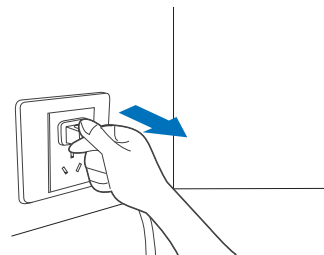

### Unfasten Safety Tether

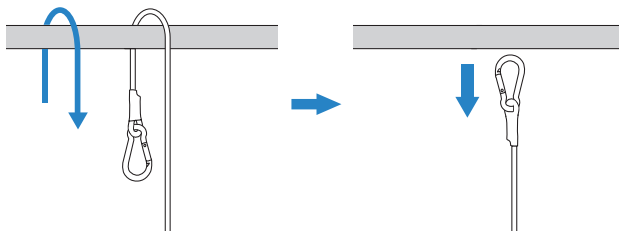

# Maintenance

## Reservoir

### Empty the Reservoir

Pour out the cleaning solution from the Reservoir.

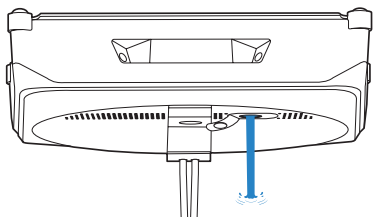

## Mopping Pad

### Replace the Mopping Pad

Remove the dirty Mopping Pad from WINBOT and place a clean new one on it. Then, press the Mopping Pad with your hands to help it stick firmly. Please make sure the Mopping Pad is correctly attached, and do not cover the Spherical Sensors.

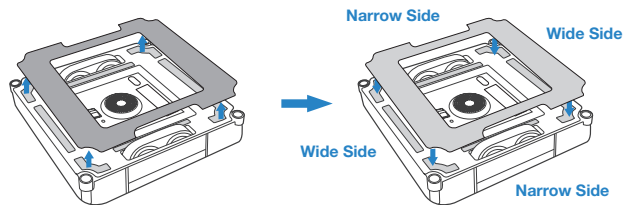

\* Clean the Velcro at the bottom of WINBOT with a clean brush if it is dirty. Do not wash with water to avoid damage caused by water.

### Wash the Mopping Pad

Remove the Mopping Pad. Wash it with tap water, and wring it dry before use.

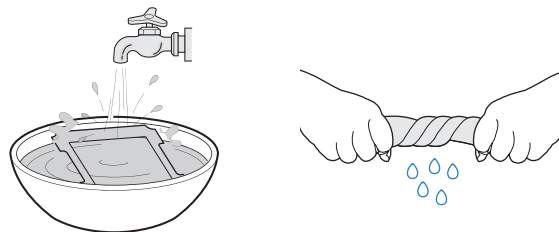

**Note:** Wash with tap water.

Washing the Mopping Pad regularly can extend its service life. If the Mopping Pad becomes worn or no longer fits exactly within the fastener area, replace it with a new one to achieve optimal cleaning performance. Explore more accessories at ECOVACS HOME App or at <https://www.ecovacs.com/global>.

## Driving Treads

1

Before maintenance, please make sure that the power switch is set to "I" and the fan stops working.

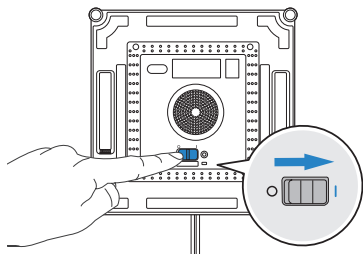

2

Inspect the Driving Treads in ECOVACS HOME App. Stop the Driving Treads if you see dirt on them.

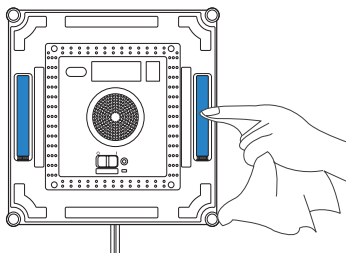

3

After maintenance, you can install the Mopping Pad to continue cleaning task. Or turn the power switch to "O" to end task.

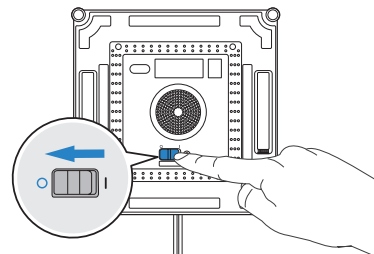

## Fan

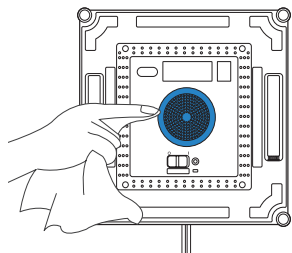

## Spherical Sensors

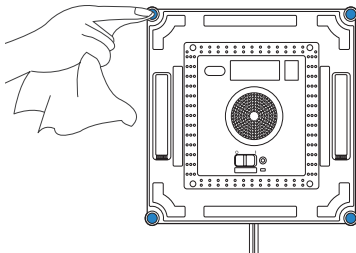

## Side Rollers

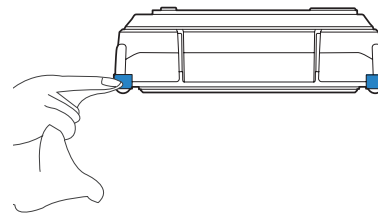

\* After WINBOT reports low battery, please fully charge it before usage and storage to avoid reducing the service life of battery.

\* If WINBOT will not be used for a long time, please fully charge it and turn it off before storage. Recharge it every six months to prevent the battery from being over-discharged.

# Status Indicator Light

Light Effect	Status
Status Indicator glows a continuous BLUE.	WINBOT is fully charged.
	WINBOT has successfully adhered itself to the glass and is ready to clean.
	WINBOT is cleaning.
	WINBOT is paused.
	The network setup is complete.
Status Indicator flashes BLUE slowly.	WINBOT is paused and charging.
Status Indicator flashes BLUE.	WINBOT is spraying.
Status Indicator stops glowing BLUE.	WINBOT is in sleep mode. Press  to wake it up.
	WINBOT is powered OFF.
Status Indicator glows a continuous RED.	WINBOT has a low battery. Please remove it from the window.
Status Indicator flashes RED.	WINBOT has a problem. Please refer to <a href="#">Troubleshooting</a> for details.

# Troubleshooting

NO.	Malfunction	Possible Causes	Solutions
1	WINBOT moves in an irregular pattern during cleaning.	The Mopping Pad is too wet.	Replace the Mopping Pad as described in <a href="#">Maintenance</a> . Use the ECOVACS WINBOT Cleaning Solution as described in manual and restart the cleaning cycle.
		The Driving Treads are dirty.	Clean the Driving Treads as described in <a href="#">Maintenance</a> .
2	WINBOT does not move.	The Mopping Pad is attached improperly.	Please remove the Mopping Pad and reattach.
		There are gaps or cracks on the surface to be cleaned.	Hold the Safety Tether or the Power Cord. Meanwhile, press Direction Buttons in ECOVACS HOME App to let the WINBOT leave the gap or barrier.
		The Mopping Pad Plate is blocked by small obstacles on the glass.	
3	WINBOT cannot move or moves in circles.	The driving treads are stuck.	Check if there is any dust or debris on the Driving Treads. If so, please clean the Driving Treads as described in <a href="#">Maintenance</a> . Start WINBOT again. If problem persists, please contact Customer Service.
4	Voice prompts insufficient water in the Reservoir.	No ECOVACS WINBOT cleaning solution in the Reservoir.	Please add ECOVACS WINBOT cleaning solution. Do not add purified water and filtered water.
5	WINBOT stays still or moves in an irregular pattern during cleaning.	The bumper rail is stuck.	Remove WINBOT from the window. Check if the bumper rail is stuck. Clean the bumper rail and restart WINBOT. If problem persists, please contact Customer Service.
		The bumper rail is damaged.	
		Spherical Sensors signal abnormality.	A. Remove the Mopping Pad and re-attach it making sure it will not cover or affect the Spherical Sensors. B. Clean the Spherical Sensors as described in <a href="#">Maintenance</a> . C. If the problem persists, please contact Customer Service.
		Fan malfunction.	A. Clean the Fan as described in <a href="#">Maintenance</a> . B. If the problem persists, please contact Customer Service.



NO.	Malfunction	Possible Causes	Solutions
6	WINBOT stops moving after adhering to the glass.	WINBOT is too close to the edge of the glass or obstacles.	Use the Direction Control buttons in the App to move WINBOT away from the problem area and at least 10 cm (3.94 in) from window corners and obstacles. Restart WINBOT. Alternatively, remove WINBOT from the window and put it at least 10 cm (3.94 in) from window corners and obstacles. Restart WINBOT.
7	WINBOT is stuck.	It is stuck by obstacles.	Fix the Safety Clasp and tether firmly. Hold WINBOT power cord and meanwhile, use ECOVACS HOME App to move WINBOT away from the stuck area. If the problem persists, please contact Customer Service.

# App Connection

**Before connection, make sure WINBOT and the mobile phone meet the following requirements:**

1. The Bluetooth of the mobile phone is turned on.
  2. The WINBOT power switch has been turned on and the indicator light has been lit.
  3. Please pair WINBOT in ECOVACS HOME App instead of the phone setting.
  4. Co-frequency interference might occur between Bluetooth and Wi-Fi. It is recommended to keep WINBOT close to the mobile phone and distant from the Wi-Fi router during pairing.
  5. If the connection failed, please try to disconnect other Bluetooth devices, make sure WINBOT is not connected to other mobile phones, and try again.
  6. Bluetooth may be disconnected if WINBOT is too distant from the phone. Try to reconnect at a short distance.
  7. For using WINBOT, you need to allow ECOVACS HOME App to obtain access to the location, Bluetooth, and mobile phone storage.
- If the problems persist after trying the above methods, please contact customer service.

# Technical Specifications

<b>WINBOT Model</b>	<b>WG888-12</b>		
Rated Input	24 V === 4 A	Rated Power	75 W
Frequency	2402-2480 MHz		
Off/Standby Mode Power	Less Than 0.50 W		
<b>Power Adapter: BLJ96W240400P-B</b>			
Input: 230 V ~ 50 Hz 2 A		Output: 24 V === 4 A 96 W	

Output power of the wireless module is less than 100 mW.

**Note:** Technical and design specifications may be changed for continues product improvement.

## 重要安全指示

使用電器設備時，應務必遵守基本注意事項，包括下列各項：







### 使用本產品前請仔細閱讀所有說明。 請妥善保管說明書

1. 生理、感官或精神能力不足或缺乏相關經驗與知識者，可在受到監督或已接受關於如何安全使用本產品的指導，並瞭解相關危險的情況下使用本產品。兒童不應將產品作為玩具玩耍。如果產品曾掉落、有明顯的損壞跡象或有滲漏情況時，請勿使用。產品通電時，請勿讓兒童接觸。
2. 請勿在過熱或過冷的環境下使用本產品或為其充電 (低於 0°C/32°F 或高於 40°C/104°F，濕度高於 85%)，否則可能影響電池壽命。
3. 本產品若要用於清潔外窗，必須妥善以扣環綁到安全位置上，且外面風速平穩，沒有下雨或下雪情形。
4. 使用前，請先使用扣環將安全電纜鎖定在堅固的室內欄杆上，並確定將擦窗機器人穩固連接。
5. 請勿在無人看管時使用本產品。為避免因產品意外墜落而造成人身傷害或財產損失，請確認擦窗機器人工作區域下方沒有人員、動物或貴重的易碎物品。
6. 請勿在 10 級以上強風的環境，或在海拔超過 2000 公尺 (6562 英尺) 的區域使用本產品。
7. 在本產品進行清潔時，請確認產品已插入插座。本產品的安全電池可在使用期間充電。安全電池可在產品拔除電源或斷電時，為本產品供電。
8. 請勿讓產品在插入插座時無人看管。
9. 僅供家用 (包括外側窗戶)。請勿在商業或工業環境中使用本產品。
10. 請勿用於破損或不平的玻璃，例如貼有靜電貼、廣告海報或是有凸起圖案的玻璃，以避免玻璃破裂或本產品墜落。請勿用於有縫隙的表面，例如有縫隙或穿孔的玻璃，或者是中間有縫隙的兩片相鄰無框玻璃，以避免本產品因吸附力不足而墜落。
11. 僅限使用製造商推薦或供應的配件。僅限使用製造商供應的變壓器。
12. 請確保電源電壓符合變壓器上標註的電壓。
13. 請勿在窗框小於 5 mm (0.2 in) 的有框玻璃上使用本產品。
14. 請勿在厚度小於 3 mm (0.12 in) 的玻璃或厚度小於 4 mm (0.16 in) 的鏡子上使用本產品。
15. 請勿在把手高度為 70~105 mm (2.76~ 4.13 in) 的玻璃或鏡子上使用本產品。
16. 請勿在油膩的窗戶上使用本產品。
17. 在高濕度環境中使用時，會影響到清潔效果。
18. 請將產品貯放在遠離高溫與可燃物的位置。
19. 陰雨天時，請勿在外側窗戶上使用本產品，以

- 避免本產品損壞或墜落的風險。
20. 如果產品並未牢固地吸附在玻璃上，或有明顯損壞情形，請勿使用本產品。
  21. 為避免觸電，請勿將產品放入水中或其他液體中。請勿將產品貯放在可能掉落或拉扯進浴缸或水槽的位置。
  22. 請勿在手還沒擦乾的情況下觸碰插頭。
  23. 為產品充電時，請勿將產品放置在其他電器設備上，並請遠離火源與液體。
  24. 請小心不要損壞電線。請勿以電源線拖曳或提拉產品、將電源線當作把手、在關窗時夾住電線，或在電源線上放置重物。請讓電線遠離高溫表面。
  25. 電線或插座已損壞時，請勿使用本產品。如果本產品無法正常運作，或曾掉落、損壞，或接觸到水，請勿使用。為避免危險，產品必須由製造商或其維修代理商進行維修。
  26. 如果電源線損壞，必須由製造商或其維修代理商更換，以免發生危險。
  27. 在清潔和維護產品前必須先將插頭從電源插座拔出。請勿拉扯電源線來拔除變壓器插頭。
  28. 為避免發生危險，安全電池應由製造商或其維修代理商進行更換。
  29. 在丟棄本產品前，必須先按照當地的法律和法規取出並丟棄安全電池。
  30. 取出電池以丟棄產品前，必須先將產品插頭從電源插座拔出。

31. 請按照當地的法律和法規處理舊電池。
32. 即使本產品已嚴重損壞，也請勿焚燒。電池在火中可能會爆炸。
33. 請務必依照本說明書中的指示使用本產品。如因不當使用造成任何損害或傷害，本公司概不負責。
- 34. 警告：**若要為電池充電，請僅使用本產品隨附的外接式供電裝置 BLJ96W240400P-B。
35. 本機器人包含僅可由專業人員更換的電池。
36. 插頭和變壓器必須在室內使用。

為符合無線射頻曝光要求，在裝置操作期間，應使此裝置和人員之間保持 20 公分或更長的距離。為確保合規性，不建議在要求距離內操作。此發射器使用的天線不得與任何其他天線或發射器同時使用。

	2 級
	短路防護安全隔離變壓器
	交換式電源供應器
	僅供室內使用
	直流電
	交流電

## 如為歐盟國家

若要參閱歐盟符合性聲明，請造訪

<https://www.ecovacs.com/global/compliance>



## 請正確丟棄本產品

此標誌表示在歐盟不能以丟棄家庭垃圾的方法處理本產品。為防止未受控制的廢物處理對環境或人體健康造成危害，請以負責任的方式回收，確保物質資源的可持續運用。如要回收使用後的裝置，請利用退還及回收系統或聯絡當時購買產品的銷售商。銷售商能安全回收本產品。

# 包裝內容

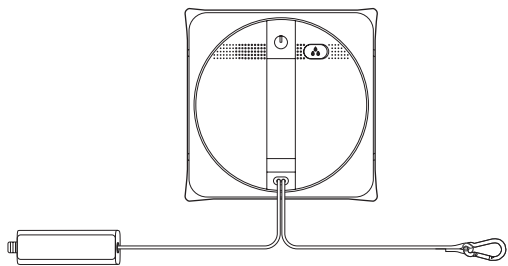

擦窗機器人 + 安全電纜及扣環 + 安全電池

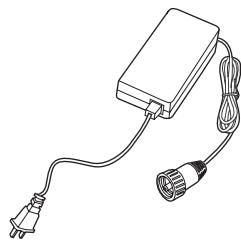

變壓器



說明書



科沃斯窗寶專用清潔液

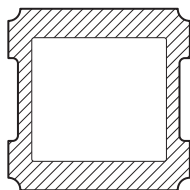

擦窗布

**備註：** 圖片與示意圖僅供參考，可能會與實際產品外觀不同。  
產品設計與規格如有變更，恕不另行通知。

# 組件名稱

## 擦窗機器人

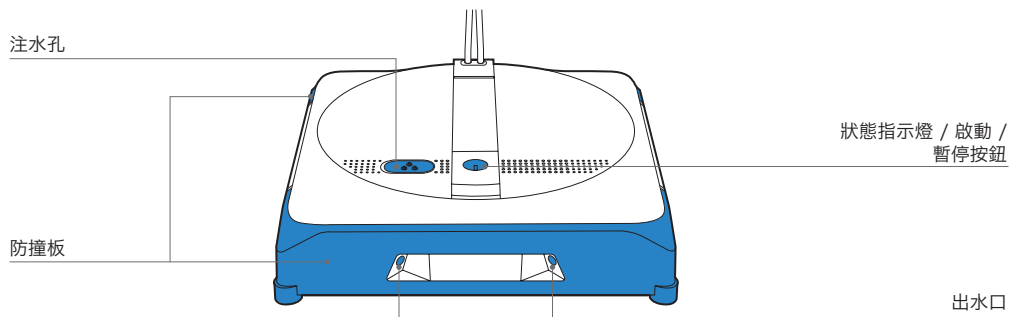

## 底部視圖

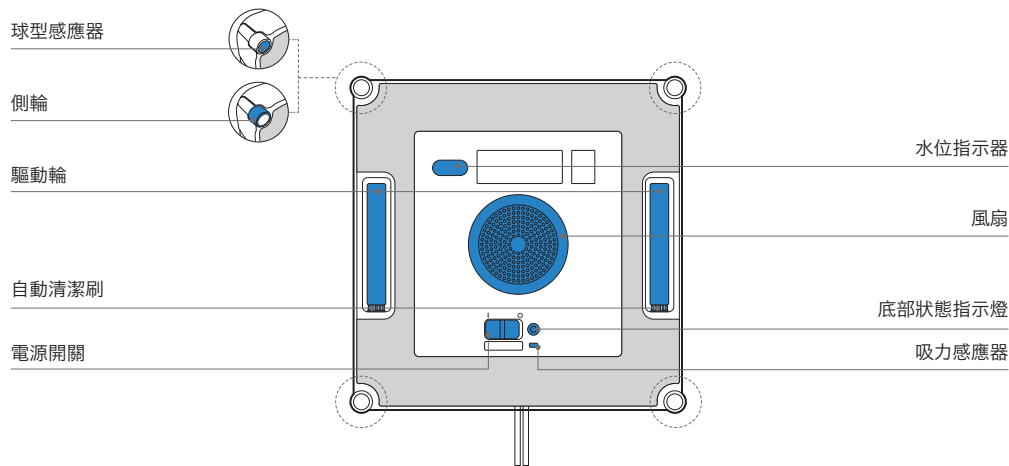



## 清潔前注意事項

使用前，請確定安全電纜和扣環已與擦窗機器人連接。(已將電纜和扣環預先連接。清潔前請勿取下。)

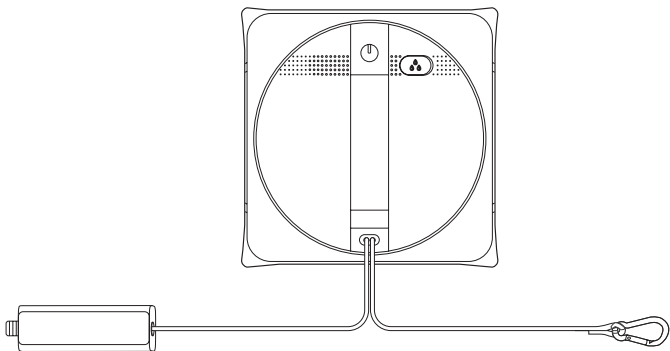

**備註：**請勿在窗框小於 5 mm (0.2 in) 的有框窗戶上使用擦窗機器人。

## 網路設定

建議透過 ECOVACS HOME App 控制您的擦窗機器人，以享受擦窗機器人所有可用的功能。

### a. 三種清潔模式

快速清潔模式：確保清潔窗戶的效率

深度清潔模式：實現零死角清潔

定點清潔模式：揮別頑強污漬

### b. 手動遙控功能，返回角落：

能在內、外窗之間切換。

手動遙控功能，可清除頑固污漬。

返回角落，讓擦窗機器人立即返回指定的角落。

### c. 自動噴水和手動噴水

預設的自動噴水功能讓您的窗戶保持清潔。

擦窗機器人也支援手動噴水。

### d. 智慧提醒更換耗材

精準的時間提醒，帶給您更好的清潔體驗。



# 快速操作

## 1 連接擦窗機器人電源線，變壓器與插頭

使用前，請確認電池已充飽電。充電時間約為 2 小時。

\* 請勿在擦窗機器人運作時切斷電源，否則可能有墜落風險。

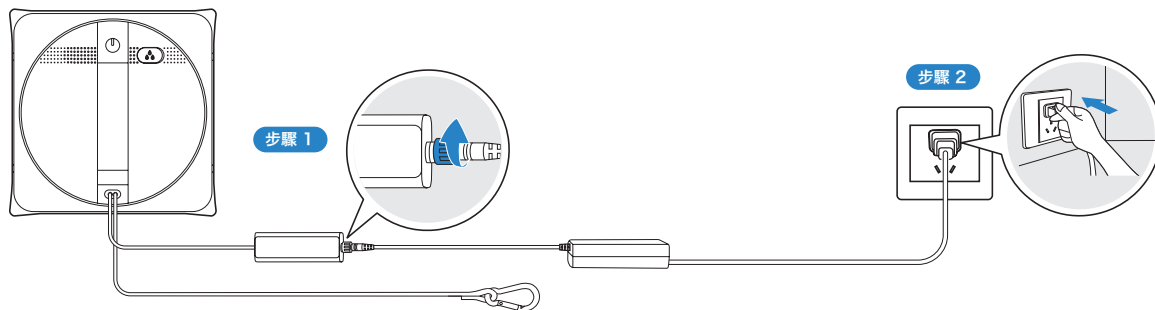

依照上方所示的順序正確連接。連接不當可能導致充電異常或電池損壞。

## 2 使用前的準備工作

### 將儲槽裝滿

建議搭配科沃斯窗寶專用清潔液使用。儲槽的最大容量約為 60ml，儲槽裝滿水時可噴灑約 60 分鐘。

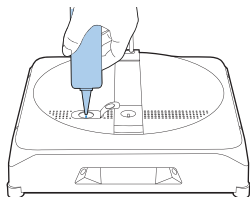

最大 60ml

**備註：** 請勿加入純水和過濾水。

請勿加入太多清潔液，導致清潔液溢出儲槽。

使用其他清潔液可能會對清潔效能造成負面影響。

如果清潔液用完，可以暫時改用水。使用科沃斯窗寶專用清潔液可提供更好的清潔效能。

## 安裝擦窗布

### ① 將擦窗布打溼

使用前，請手動將擦窗布打濕。



### ② 擰乾擦窗布

將擦窗布上的水擰乾。若要確保清潔效果，請盡量將其擰乾。

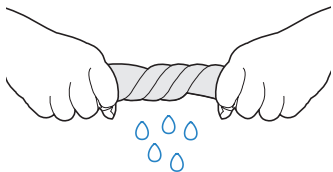

### ③ 貼上擦窗布

將擦窗布貼到擦窗機器人底部的魔術貼上，用手按壓，讓擦窗布牢牢固定。

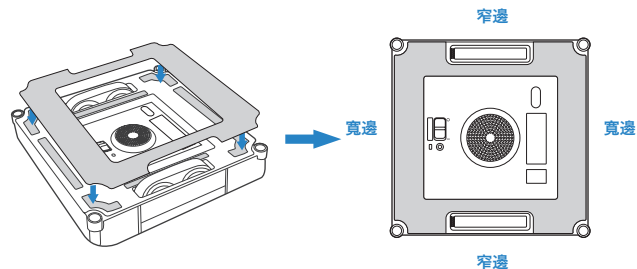

## 綁上安全電纜

將安全電纜正確綁在無法輕易移動的穩定物體上（例如桌腿、椅子腳、床腿、沙發腳、窗簾桿、樓梯扶手等），並鎖上扣環，如下圖所示。  
掛上繩索，將繩索繼續繞在支撐物上。  
打開扣環，然後將它固定在另一側的繩索上。

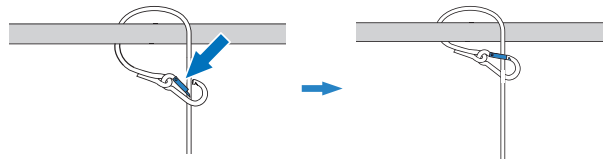

**備註：**為確保安全，使用前請務必確保扣環已穩固固定。  
建議將安全電纜隨同扣環固定在堅固安全的金屬欄杆上。

### 3 啟動

- ① 將電源開關撥至「I」。
- ② 將本產品黏附在窗戶上。

**方法 1：**快速按下擦窗機器人上的 **1**，然後將其黏附至玻璃上。

**方法 2：**為確保產品牢固吸附，將擦窗機器人平均按壓在玻璃 3 秒以上，直到您聽到語音提示為止。

擦窗機器人成功吸附在窗戶上後，就會開始清潔。

\* 清潔無框玻璃時，請勿將擦窗機器人黏附在太靠近邊緣的地方。建議距離邊緣 10 cm (3.94 in) 以上。

\* 擦窗機器人只能清潔平坦的表面。請確認玻璃厚度不小於 3 mm (0.12 in)。

\* 電源開啟後，請勿將風扇靠近頭髮和其他細小物品，以免阻塞風扇。

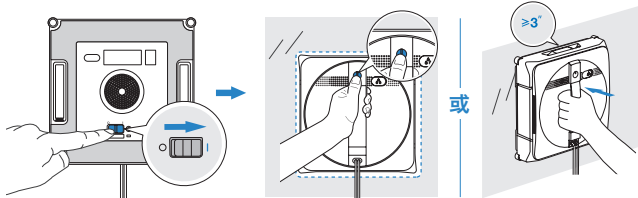

### 4 清潔期間的維護保養

對於嚴重髒污的玻璃，請多次清洗或更換擦窗布，並及時清潔四個球型感應器。

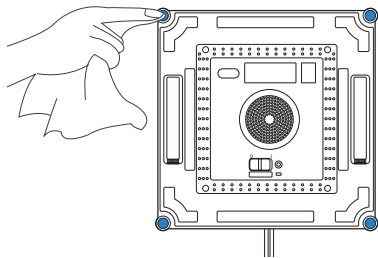

### 5 完成

#### 暫停

清潔時，按下擦窗機器人上的 **1** 或透過應用程式暫停。

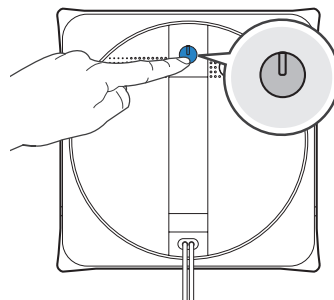

#### 取下擦窗機器人

完成清潔後，擦窗機器人將返回起始位置並發出「嗶」聲。按住 **1** 5 秒以上，並在風扇停止運轉後將其取下。

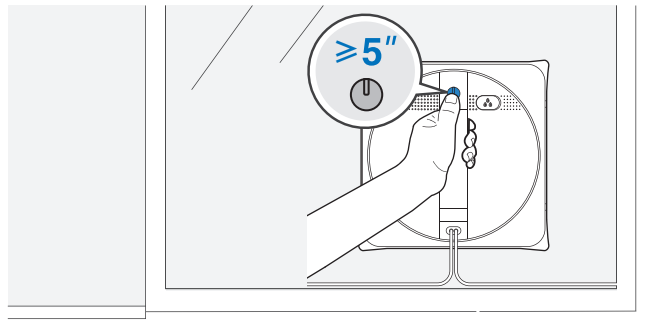

### 關機

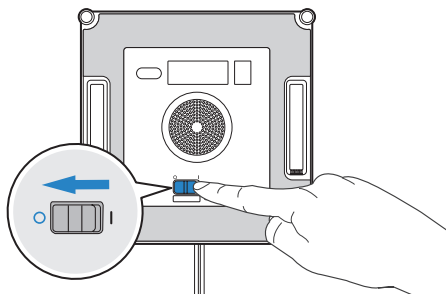

### 拔下電源插頭

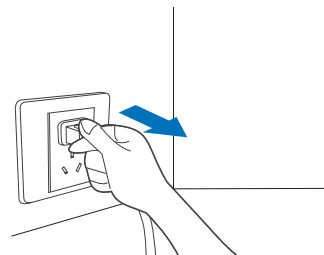

### 解開安全電纜

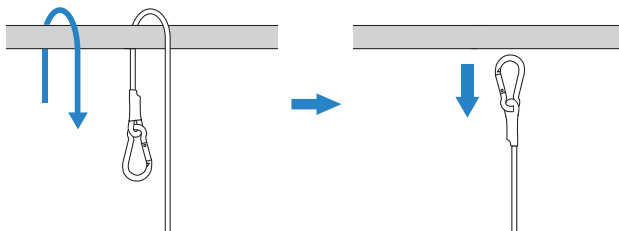

# 維護保養

## 儲槽

### 清空儲槽

倒出儲槽內的清潔液。使用科沃斯窗寶專用清潔液後，請以隨附的量杯沖洗儲槽。

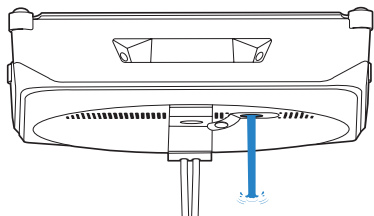

## 擦窗布

### 更換擦窗布

從擦窗機器人上移除骯髒的擦窗布，並貼上乾淨的新擦窗布。然後用手按壓擦窗布，讓它牢牢貼上。請確定擦窗布已正確黏附，且未蓋住球型感應器。

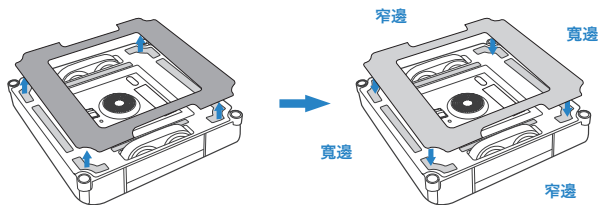

\* 如果擦窗機器人底部的魔術貼變髒了，請使用乾淨的刷子清理。請勿用水清洗，以避免進水造成損壞。

### 清洗擦窗布

取下擦窗布。請用自來水清洗，使用前請將其擰乾。

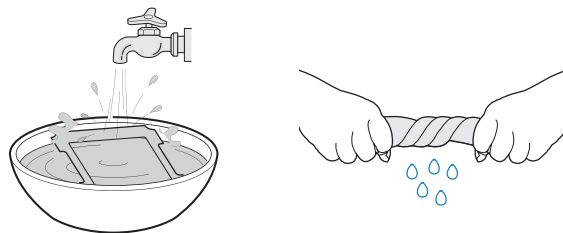

**備註：**用自來水清洗。

定期清洗擦窗布可延長其使用壽命。

如果擦窗布變得破舊或再也無法與黏附區域完全貼合，請更換為新的擦窗布以達到最佳清潔效能。

若須探索更多配件，歡迎前往 ECOVACS HOME App 或 <https://www.ecovacs.com/global>。

## 驅動輪

1

進行維護保養前，請確定電源開關設定為「I」，且風扇停止運作。

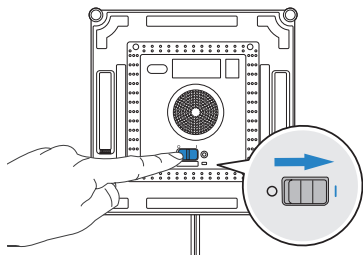

2

透過 ECOVACS HOME App 檢查驅動輪。如果在驅動輪上發現髒污，請停止驅動輪。

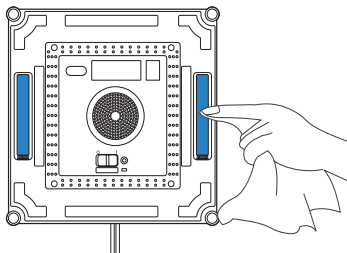

3

維護保養後，您可以安裝擦窗布以繼續清潔工作。或將電源開關撥至「O」以結束工作。

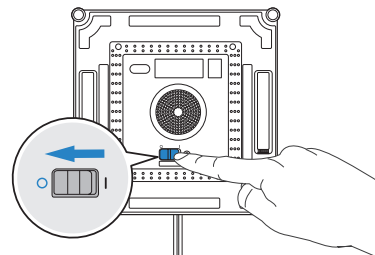

## 風扇

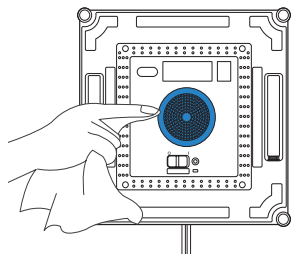

## 球型感應器

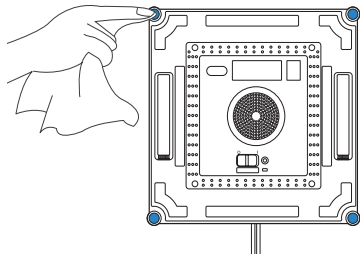

## 側輪

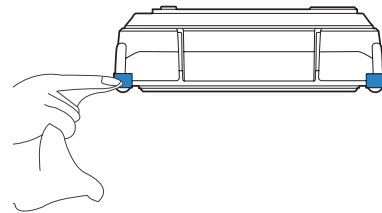

- \* 擦窗機器人報告電池電量不足後，請將電池充飽電後再使用或存放，以避免縮短電池的使用壽命。
- \* 如果長期不使用擦窗機器人，請將其充飽電後再存放。請每六個月充電一次，以免電池過度放電。

# 狀態指示燈

亮燈效果	狀態
狀態指示燈持續亮藍光。	擦窗機器人已充飽電。
	擦窗機器人已成功吸附在玻璃上，並準備好進行清潔。
	擦窗機器人正在清潔。
	擦窗機器人已暫停。
	網路設定已完成。
狀態指示燈緩慢閃爍藍光。	擦窗機器人已暫停且正在充電。
狀態指示燈閃爍藍光。	擦窗機器人正在灑水。
狀態指示燈藍光熄滅。	擦窗機器人處於睡眠模式。按下  將其喚醒。
	擦窗機器人關機。
狀態指示燈持續亮紅光。	擦窗機器人電池電量不足。請從窗戶上取下。
狀態指示燈閃爍紅光。	擦窗機器人發生問題。請參閱「 <a href="#">故障排除</a> 」以取得詳細資訊。



# 故障排除

編號	故障情況	可能原因	解決方法
1	擦窗機器人在清潔時以異常的行進路線移動。	擦窗布太濕。	請依照「 <a href="#">維護保養</a> 」所述更換擦窗布。請依照說明書所述，使用科沃斯窗寶專用清潔液，並重新啟動清潔循環。
		驅動輪太髒。	請依照「 <a href="#">維護保養</a> 」所述清潔驅動輪。
2	擦窗機器人不會移動。	擦窗布未正確黏附。	請取下擦窗布並重新黏附。
		要清潔的表面上有縫隙或裂痕。	拉住安全電纜或電線。同時，在 ECOVACS HOME App 中按下方向按鈕，讓擦窗機器人離開縫隙或障礙物。
		擦窗布板被玻璃上的小障礙物卡住。	
3	擦窗機器人無法移動或是在原地打轉。	驅動輪卡住。	檢查驅動輪上是否有灰塵或碎屑。如果是，請依照「 <a href="#">維護保養</a> 」所述清潔驅動輪。再次啟動擦窗機器人。如果問題持續，請聯絡客戶服務。
4	語音提示儲槽水量不足。	儲槽中沒有科沃斯窗寶專用清潔液。	請倒入科沃斯窗寶專用清潔液。請勿加入純水和過濾水。
5	擦窗機器人清潔時停留在原地，或以異常的行進路線移動。	防撞板卡住。	從窗戶取下擦窗機器人。檢查防撞板是否卡住。清潔防撞板並重新啟動擦窗機器人。如果問題持續，請聯絡客戶服務。
		防撞板損壞。	
		球型感應器訊號異常。	A. 取下擦窗布並重新黏附，確認擦窗布並未覆蓋或影響球型感應器。 B. 按照「 <a href="#">維護保養</a> 」所述清潔球型感應器。 C. 如果問題持續，請聯絡客戶服務。
		風扇故障。	A. 依照「 <a href="#">維護保養</a> 」所述清潔風扇。 B. 如果問題持續，請聯絡客戶服務。
6	擦窗機器人吸附在玻璃後停止移動。	擦窗機器人距離玻璃邊緣或障礙物太近。	使用應用程式中的方向控制按鈕，讓擦窗機器人離開問題區域，且至少離窗戶角落和障礙物 10 cm (3.94 in) 遠。重新啟動擦窗機器人。或者，從窗戶上取下擦窗機器人，並將其放在距離窗戶角落和障礙物至少 10 cm (3.94 in) 的位置。重新啟動擦窗機器人。
7	擦窗機器人卡住。	被障礙物卡住。	固定安全鎖扣與電纜。拉住擦窗機器人電線，並同時使用 ECOVACS HOME App 讓擦窗機器人離開受困區域。如果問題持續，請聯絡客戶服務。

# 應用程式連線

連線前，請確認擦窗機器人和手機符合下列需求：

1. 手機的藍牙功能已開啟。
2. 擦窗機器人電源開關已開啟，且指示燈已亮起。
3. 請在 ECOVACS HOME App 中與擦窗機器人配對，而非透過手機設定。
4. 藍牙和 Wi-Fi 之間可能會發生同頻干擾。在配對期間，建議讓擦窗機器人靠近手機，並遠離 Wi-Fi 路由器。
5. 如果連線失敗，請嘗試中斷其他藍牙裝置的連線，確定擦窗機器人並未連線至其他手機，然後再試一次。
6. 如果擦窗機器人離手機太遠，藍牙連線可能會中斷。請嘗試在近距離重新連線。
7. 若要使用擦窗機器人，您必須允許 ECOVACS HOME App 獲得存取位置、藍牙和手機儲存空間的權限。嘗試上述方法後，如果問題持續，請聯絡客戶服務。

## 產品內容

產品型號	WG888-12		
額定輸入	24 V === 4 A	額定功率	75 W
頻率	2402-2480 MHz		
關機 / 待機模式功率	小於 0.50 W		
<b>變壓器: BLJ96W240400P-B</b>			
輸入: 230 V ~、50 Hz 2 A		輸出: 24 V === 4 A 96 W	

無線模組的輸出功率小於 100 mW。

**備註:** 因產品持續改善的需要, 本公司保留對產品進行任何技術、設計變更的權利, 解釋權歸本公司所有。

**Ecovacs Home Service Robotics Co., Ltd.**

No. 518 Songwei Road, Wusongjiang industry Park, Guoxiang Street,  
Wuzhong District, Suzhou, Jiangsu, China.

451-2112-8501